

Best-selling

dental instruments in Scandinavia

Introducing



IDX Plus



16 years of excellence

New edition - MA Dental is glad to provide you with the most up-to-date edition of our dental instrument catalog. It comprises our entire line of dental and surgical instruments, as well as our InstruDents ergonomic silicone line (IDX). Our newest collection of IDX Plus is also a part of this catalog.

We are constantly expanding our product line with new and innovative products. Please visit our website at www.madental.dk for the most up-to-date product information.

Profile - MA Dental is a danish company (formerly MA Medicals), established by a Danish sport surgeon in 2007. We specialize in designing & developing premium-quality dental instruments with the singular aim of providing innovative, quality instruments to dental professionals all around the world. Our primary focus is to keep quality high and prices low to enable dental clinics to always purchase quality instruments without the constant worry of high cost.

Quality & Guarantee:- All MA Dental instruments are manufactured under strict quality control conditions, and all are made with premium-grade stainless steel. The instruments go through a unique process of passivation which ensures a strong resistance against rust and extends further their long-life and durability. We guarantee your full satisfaction and take responsibility for any manufacturing defects, no matter how unusual or unlikely. Visit our website at www.madental.dk to learn more about our quality and guarantee.

You can check more on our website

www.madental.dk

www.instrudents.com

You can also contact us by email at

info@madental.dk

or give us a call at

+45 70 60 59 22

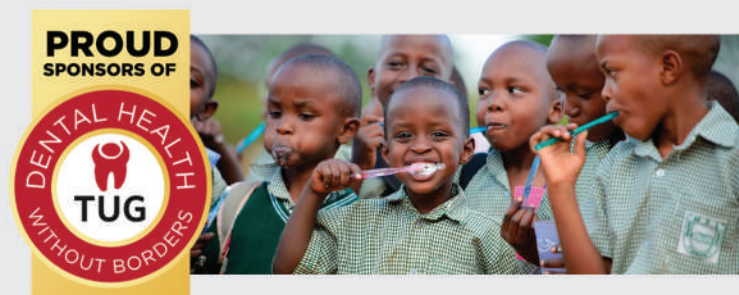

Content

Periodontics

07

Sharp instruments	08-10
Gracey curettes	11-12
Mini Gracey & Rigid Gracey	13
Universal Curettes	14-15
Sickle Scalers	16-17
Perio kits	18-20

Diagnostic

21

Explorers	22
Periodontal Probes	23
Expros: Explorer + Periodontal Probes	24-25
Mouth Mirrors and handles	26
Diagnostic kits	27

Conservative instruments

28

Excavators	29-30
Composite instruments	31-36
Restoration / Composite kits	37
Rubberdam instruments / Clamps	38-39
Matrix retainers / Crown instruments	40

Extraction

41

Extraction Forceps	42-46
Root tip elevators	47-52

Oral & Micro Surgery

53

Scissors	54-57
Needle holders	58-59
Hemostatic Forceps	60
Tweezers	61-62
Retractors	63
Endodontic instruments	64-65
Orthodontics	66-67
Implantology	68-73
Syringes	74
Bone Curettes	75-76
Periosteal elevators	77
Surgery kits	78-80

Diverse

81

Sterilization cassettes	82-83
Trays & accessories	84-85
Scalpel, rulers, color-coded rings	86

What our **customers** say about us



Dr Anil Shrestha

BDS, BSc(Hons), DGDP(UK), MGDS
RCS(Eng), MSc(Lond), MFDS RCSEd.,
MFDS RCPS(Glas), FFGDP RCS(Eng),
FICD., Clinical Director / Registered
Specialist in Prosthodontics - Wimpole
Street, London W1G

"Having only ever used premium surgical instruments for the past 20 years, I have very discerning and exacting requirements of my hand instruments to enable me to produce the consistently high quality of work required in private specialist practice. The selection of restorative instruments from INSTRUMENTS IDX complement my usual instruments perfectly; they are in many ways a natural evolution of instrument design, incorporating the comfort of modern silicone handles, near-perfect balance-points, exceptionally comfortable ergonomic design, and quality working tips. The clear and legible labelling on the instrument handles and the distinctive colour coding make the identification and selection of these instruments almost intuitive, a pleasant bonus that my dental nurses really appreciate. My hygienists love these instruments for their daily work too and I look forward to seeing the range of instruments broaden in the future."

Dr Maria Kocisova MDDr

Associate Dentist | London, UK



"As a cosmetic dentist I do many composite restorations on a daily basis. I enjoy using the IDX composite modelling instruments as they offer excellent non-stick properties that add efficiency to my clinical procedures. These ergonomic instruments have tools on each end, designed to carry the composite resin to the prep, packing it into place and smoothening out the surface. The plugger end is designed to help avoid composite pullback. All are fully autoclavable."

"The ergonomic handle rests easily, naturally and comfortably in my grasp. The textured handle surface provides better traction and stability"

Sonja Novovic

Clinic Manager | Falkonertandlægerne | Denmark.



"For the past six years, I've been purchasing MA Dental instruments. I've used a number of their instruments, but my favorites are their surgical instruments, Manage cassettes, and 1 mm probes. Their instruments are of outstanding quality and are extremely helpful during our hectic clinic days."

"MA Dental is very flexible in how they work, and they are a great help when I need some particular instrument. It has always been a pleasure working with MA Dental."

Zoya El-Niggar

Glentevej-Tandklinik | Køge, Denmark



"For quite some time, I've been using MA Dental's instruments. I recently had the opportunity to try out their latest IDX instruments. The instrument has an exquisite build and an ergonomic tail. Even if I use them for the whole day, they provide me with a great deal of ease."

"Our dental kits are simple to handle because of the color range available in Manage cassettes, and they also leave a good impact on our patients. These dental instruments are highly recommended by me."



InstruDents®

By MA THE EXTENSION OF A DENTIST'S HAND



Periotome 2
IDK 13053
CE

12 mm

ANTI-RUST
INSTRUMENT

FEEL THE
GRIP!

FULLY AUTOCLAVEABLE

PERFECTLY
BALANCED

EXCELLENT
CRAFTSMANSHIP

15g

LIGHT WEIGHT

18g

EXCITING COLORS



Pr 2mm (b) + Exp 23
IDXP 11008
CE

13.5 mm

IDX PLUS

IDX

Premium Instrument

There are two types of titanium oxide coated instruments available. (1) Fully titanium coated (2) Only the handle is titanium coated. Titanium coating is a highly scratch resistant material applied on the instrument and has a long working life as compared to non-coated instruments. It has several benefits such as: Its hygiene friendly, easy to clean, non-stick & sharpen free instrument (only fully titanium coated)

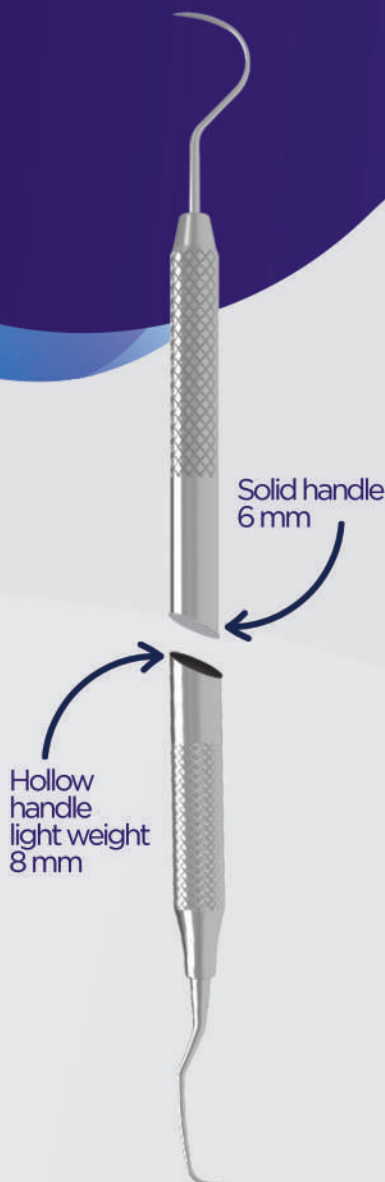

Re-Sharpenable
working end

Available in

Titanium
Oxide Coated
Grip - Easy to
Clean!

Non-stick
working-end
Hygeine friendly
Easy to clean

Hollow
handle
light weight



Classic Instrument

The classic instruments series are single-ended and double-ended instruments, produced with high quality stainless steel with economic prices without compromising on the quality of the instruments. There are two types of instruments available in classic series: (1) C8: Hollow stainless steel handle (2) Solid stainless steel handle

Periodontics



Sharp instruments

Gracey curettes

Universal Curettes

Mini Gracey & Rigid Gracey

Sickle Scalers | Perio kits

Sharp Instruments

Sharper - Harder - Durable



Sharp instruments are available with two handle options. One is in a premium handle (black titanium coated). The second option is the IDX ergonomic silicone handle. Sharp instruments are manufactured with premium quality sharp Swiss steel. Most dental instruments have an HRC rating of 51-53. HRC is the recognized industry rating that defines the sharpness of an instrument. Due to our unique heat treatment, the IDX Sharp has achieved a robust 60 HRC ensuring a supreme sharpness longevity.

All of our sharp instruments are non-stick & completely sharpen-free. Sharp instruments have supreme wear resistance and durability and maintain a long-lasting sharpness. Special black titanium oxide coating on the instruments ensures that they are easy to clean, hygiene friendly and give minimal reflection while being used.

Features!

- Sharpen free & non-stick
- Supreme wear resistant
- Durable & long lasting sharpness
- Easy to clean & hygiene friendly
- Minimal reflection

 **Swiss Steel**



Sharp Instruments

Gracey curettes

- ◆ All-surfaces
- ◆ Buccal/Lingual
- ◆ Mesial
- ◆ Distal

Handle Option



Mini Gracey 1-2

Pi 1701 **IDX** 15001 ◆



Mini Gracey 11-12

Pi 1702 **IDX** 15002 ◆



Mini Gracey 13-14

Pi 1703 **IDX** 15003 ◆



Mini Gracey 15-16

Pi 1704 **IDX** 15004 ◆



Mini Gracey 17-18

Pi 1705 **IDX** 15005 ◆



Gracey 1-2

Pi 1708 **IDX** 15008 ◆



Gracey 11-12

Pi 1709 **IDX** 15009 ◆



Gracey 13-14

Pi 1710 **IDX** 15010 ◆



Gracey 7-8

Pi 1715 **IDX** 15015 ◆



See more sharp instruments at www.madental.dk

Sharp Instruments

Sickle Scalers

Handle Option



Pi Premium
10 mm hollow



Idx Ergonomic
Silicone 12 mm

Mini Sickle 11-12

Pi 1717

Idx 15017



Micro Sickle 01-02

Pi 1718

Idx 15018



Sharp Jack Scaler

Pi 1758

Idx 15058



Nebraska 128

Pi 1759

Idx 15059



H6-H7

Pi 1724

Idx 15024



M23

Pi 1722

Idx 15022



Columbia 4L-4R

Pi 1726









Idx 15026



Gracey Curettes

Scaling and root planing are commonly performed with Gracey curettes. Since the instrument's configuration allows for better adaptation to the anatomy of the roots, these curettes are particularly useful for removing subgingival calculus.

◆ All-surfaces ◆ Mesial ◆ Buccal/Lingual ◆ Distal

<p>Gracey curette: 1-2 NEW</p>  <p>C8 1282-1 C6 1582-1 IDX 13008 IDXP 13008</p>	<p>Gracey curette: 3-4 NEW</p>  <p>C8 1282-2 C6 1582-2 IDX 13013 IDXP 13013</p>	<p>Gracey curette: 5-6 NEW</p>  <p>C8 1282-3 C6 1582-3 IDX 13014 IDXP 13014</p>	<p>Gracey curette: 9-10 NEW</p>  <p>C8 1282-5 C6 1582-5 IDX 13016 IDXP 13016</p>
<p>Gracey curette: 7-8 NEW</p>  <p>C8 1282-4 C6 1582-4 IDX 13015 IDXP 13015</p>	<p>Gracey curette: 11-12 NEW</p>  <p>C8 1282-6 C6 1582-6 IDX 13009 IDXP 13009</p>	<p>Gracey curette: 11-14</p>  <p>Pi 1011-14 IDX 13060</p>	<p>Gracey curette: 12-13</p>  <p>Pi 1012-13 IDX 13061</p>

Handle Option

- C6** 6 mm solid
- C8** 8 mm hollow
- Pi** Premium 10 mm hollow
- IDX** Ergonomic Silicone 12 mm
- IDXP** Ergonomic Plus Silicone 13 mm

Gracey curette: 13-14 **NEW**

IDX 13010 **C6** 1582-7 **C8** 1282-7 **IDXP** 13010 ◆



Gracey curette: 15-16 **NEW**

IDX 13011 **C6** 1582-8 **C8** 1282-8 **IDXP** 13011 ◆



Gracey curette: 17-18 **NEW**

IDX 13012 **C6** 1582-9 **C8** 1282-9 **IDXP** 13012 ◆



Non-stick Gracey curettes

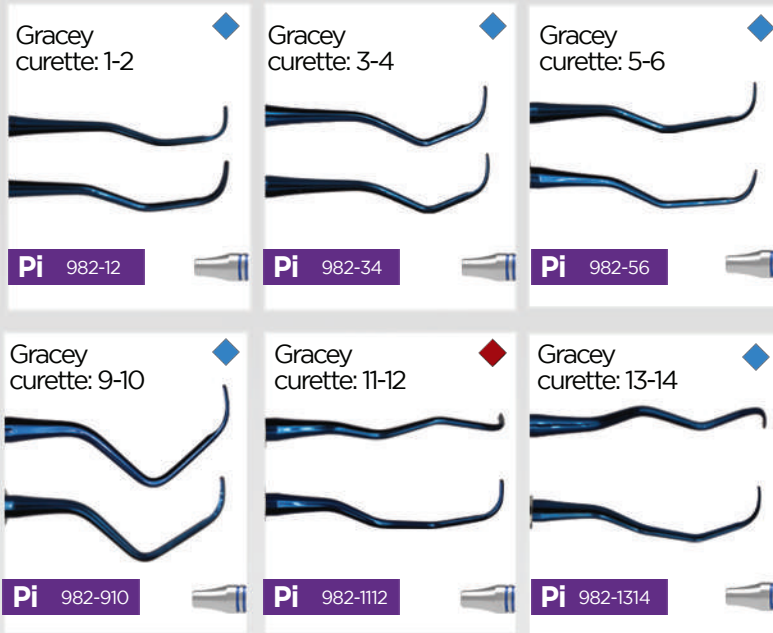

8 pcs
Non-stick
standard gracey
curette kit
982

Gracey curette: 7-8

Pi 982-78



Gracey curettes types

Mini

Ideal for scaling deep, narrow pockets

Blade shank 50% less & 10% thinner

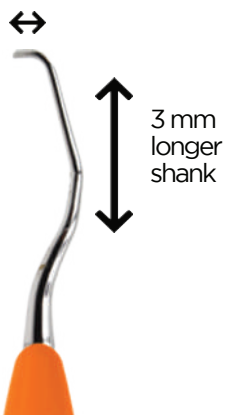

Standard

Ideal for removing subgingival calculus.



Rigid

Ideal for more pressure to be applied.

Thicker, rigid & wider working-end than standard Gracey



Mini Gracey curettes

Mini Gracey curettes have a 3mm longer terminal shank than normal Gracey curettes. The blade shank of the mini Gracey curette is 50% shorter and 10% thinner than that of the regular Gracey curette. Scaling deep, narrow pockets with mini Gracey curettes is a smart idea.

- ◆ All-surfaces
- ◆ Mesial
- ◆ Buccal/Lingual
- ◆ Distal



Handle Option



IDX Ergonomic Silicone 12 mm

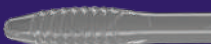

IDXP Ergonomic Plus Silicone 13 mm

Mini Gracey 11-12 NEW

- IDX** 13002 NEW ◆ **IDXP** 13002 ◆



Mini Gracey 13-14 NEW

- IDX** 13003 NEW **IDXP** 13003 ◆



Rigid Gracey

Rigid Gracey's blade shank is thicker and more rigid than the regular model, and its working end is slightly wider.

Rigid Gracey 11-12

- IDX** 13006 ◆







Rigid Gracey 13-14

- IDX** 13007 ◆

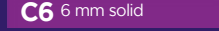

Universal currettes

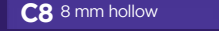
Handle Option

-  **C6** 6 mm solid
-  **C8** 8 mm hollow
-  **Pi** Premium 10 mm hollow
-  **IDX** Ergonomic Silicone 12 mm
-  **IDXP** Ergonomic Plus Silicone 13 mm



Columbia 4L-4R



Langer Currettes

Barnhart Currettes



Mini Langer Currettes

Soft tissue Currettes

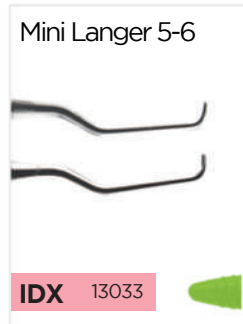
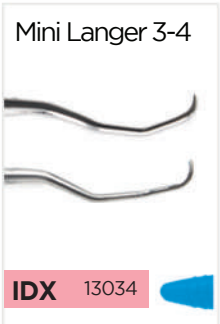
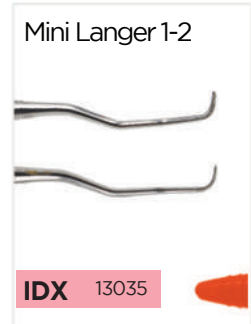

Goldman-Fox 3



Universal cures

Duplex cures

Duplex cures are the combination of gracey cure and Universal cure into one instrument

Mini Duplex cures

Universal cure and Gracey 11/12 and Gracey 13/14 cures - Mini Duplex cure is ideal for narrow and deep pockets

IDX 13020



Duplex cure

Gracey 11/12 for mesial surfaces and Gracey 13/14 for distal surfaces

IDX 13021



McCalls cures

Mini McCall 13S-14S

IDX 13031 **C8** 1225 **C6** 1525



McCall 13S-14S

IDX 13059



McCall 17-18

IDX 13032



M23A

IDX 13023



Handle Option



C6 6 mm solid



C8 8 mm hollow



IDX Ergonomic Silicone 12 mm

Sickle Scalers

Micro Sickle 01-02 **NEW**

IDX 13018 **IDXP** 13018



Mini Sickle 11-12 **NEW**

IDX 13017 **IDXP** 13017



204SD **NEW**

IDX 13039 **IDXP** 13039



Furcator Scaler

IDX 13057



H6-H7

IDX 13024



204S

IDX 13038



M23 Universal Scaler

IDX 13022 **C6** 1510-76 **C8** 1210-76 **Pi** 1076P



Crane-Kaplan

IDX 13019



Handle Option



C6 6 mm solid



C8 8 mm hollow



IDX Ergonomic Silicone 12 mm



IDXP Ergonomic Plus Silicone 13 mm

Sickle Scalers

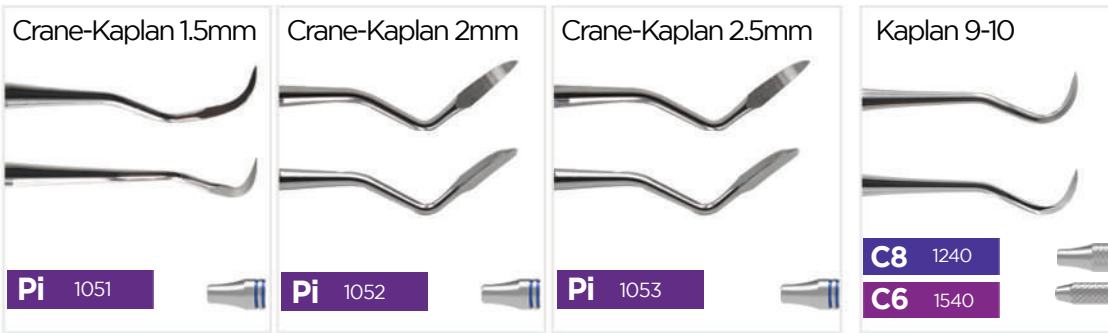

Handle Option

-  C6 6 mm solid
-  C8 8 mm hollow
-  Pi Premium 10 mm hollow
-  IDX Ergonomic Silicone 12 mm

Hoe Scaler

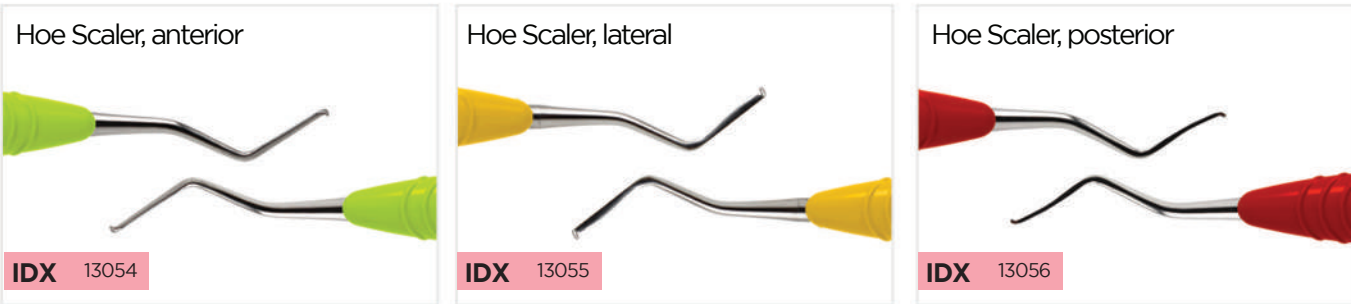

Non-stick Sickle Scalers

Easy to clean, hygiene friendly, minimal reflection, sharpen free

Sickle Scaler 204S

Pi 1011



Sickle Scaler 204SD

Pi 1075



Sickle Scaler H6-H7

Pi 986 H6-H7



Perio kits

Mini Hygiene set IDX 17085

The Mini Hygiene kit features five instruments, including a hygiene scaler and commonly used Gracey curettes for particular areas. Either a Manage-5 (Plastic) or Mini-5 (Stainless-steel) cassette is available with this package.

IDX 13024 | H6-H7 - Hygiene scaler

IDX 13008 | Gracey 1-2

IDX 13015 | Gracey 7-8

IDX 13016 | Gracey 9-10

IDX 13009 | Gracey 11-12

Manage5 cassette or Mini stainless steel cassette



Mini Hygiene set with small tray (stainless steel)

IDX 17085s



Basic Hygienist kit IDX 17088

A Swedish dentist has created this hygienist pack. It's the ideal starter kit for hygienists, with instruments ranging from Explorers to Curettes and Scalers.

IDX 11001 | Explorer 17-23

IDX 11019 | Mirror handle, Special blue

IDX 13031 | Mini McCall 13S-14S

IDX 14006 | Periodontal Probe CP12

IDX 13017 Mini Sickle Scaler

Manage5 cassette or Mini stainless steel cassette



Basic Hygienist kit with small tray (stainless steel)

IDX 17088s



Perio kits

Tartar remover set IDX 17087

From diagnostics to sickle scalers and universal curettes, the Tartar Remover Package includes 5 all-purpose instruments. Either a Manage-5 (Plastic) or Mini-5 (Stainless-steel) cassette is available with this package.

IDX 11001 | Explorer 17-23

IDX 13024 | Sickle Scaler H6-H7

IDX 11018 Mirror handle with Front-Surface mirror no. 4

IDX 13022 M23 Universal Curette

IDX 13017 Mini Sickle Scaler

Manage5 cassette or Mini stainless steel cassette



Tartar remover set with small tray (stainless steel)

IDX 17087s



Basic Perio set IDX 17084

Basic perio set contains 5 instrument from scaling to mostly used area specific Gracey curettes. Either a Manage-5 (Plastic) or Mini-5 (Stainless-steel) cassette is available with this package.

IDX 13017 | Mini Sickle Scaler

IDX 13032 | Curette McCall 17-18

IDX 13008 | Gracey 1-2

IDX 13009 | Gracey 11-12

IDX 13010 | Gracey 13-14

Manage5 cassette or Mini stainless steel cassette



Basic Perio set with small tray (stainless steel)

IDX 17084s



Perio kits

All - Round Perio Set IDX 17083

All-round perio set contains of periodontics instruments and one sterilization tray (Either Mange-9 (plastic) or Medium (stainless steel))

- IDX 13017 | Mini Sickle Scaler
- IDX 13019 | Crane-Kaplan
- IDX 13032 | McCall 17-18 Curette
- IDX 13008 | Gracey 1-2
- IDX 13016 | Gracey 9-10
- IDX 13009 | Gracey 11-12
- IDX 13010 | Gracey 13-14
- IDX 13011 | Gracey 15-16
- IDX 13018 | Micro Sickle Scaler



All Round Perio set
(stainless steel)

IDX 17083s



Perio Diagnostic Set IDX 17086

The Perio Diagnostic collection comprises five instruments, ranging from diagnostic instruments to scalers, as well as area specific Gracey curettes. Either a Manage-5 (Plastic) or Mini-5 (Stainless-steel) cassette is available with this package.

- IDX 13019 Micro Sickle Scaler
- IDX 11018 Mirror handle with Front-Surface mirror no. 4
- IDX 11012 Explorer 8 - Periodontal probe (2mm)
- IDX 13009 Gracey 11-12
- IDX 13010 Gracey 13-14
- Manage5 cassette or Mini stainless steel cassette



Perio Diagnostic
set with small tray
(stainless steel)

IDX 17086s



Diagnosics

Three dental diagnostic instruments are shown vertically. The leftmost instrument is a grey explorer with a curved tip. The middle instrument is a blue periodontal probe with a long, thin shaft and a curved tip. The rightmost instrument is a green dental mirror with a circular head and a curved shaft. The background features abstract blue and purple curved shapes.





Explorers

Periodontal Probes

Expros: Explorer
+ Periodontal Probes

Explorers

Single end

<p>Explorer 23</p>  <p>Pi 1033-5 IDX 14001</p>	<p>Explorer 33</p>  <p>Pi 1033 IDX 14002</p>	<p>Explorer-Holst</p>  <p>C8 1228 C6 1528</p>
<p>Explorer 3A</p>  <p>Pi 1031</p>	<p>Explorer 29</p>  <p>IDX 14004</p>	

Handle Option

- C6** 6 mm solid
- C8** 8 mm hollow
- Pi** Premium 10 mm hollow
- Active Explorer 13** 13 mm hollow
- IDX** Ergonomic Silicone 12 mm
- IDXP** Ergonomic Plus Silicone 13 mm



Explorer 9





- Pi** 1033-9
- IDX** 14003

Explorers

Double end

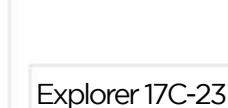
- Explorer 5-8 **NEW**
IDX 11004 **IDXP** 11004

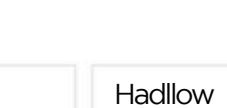
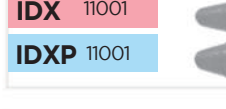
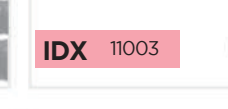

<p>NEW Explorer 17-23</p>  <p>C6 1540-4 Pi 1040-4 IDX 11001 IDXP 11001</p>	<p>Explorer 17C-23</p>  <p>IDX 11003</p>	<p>Weston</p>  <p>C8 1229 C6 1529</p>	<p>Hadllow</p>  <p>Pi 1040-1</p>
<p>Explorer 2H</p>  <p>Pi 1040-2</p>	<p>Explorer 2A</p>  <p>C8 1271-2A</p>	<p>Explorer 5-9 NEW</p>  <p>IDX 11002 IDXP 11002</p>	<p>Explorer 9-17 NEW</p>  <p>IDX 11031</p>

Periodontal Probes

Periodontal probes are marked with a high-quality black-marking, which extends the instrument's life and makes it last longer than most probes on the market.

<p>Probe CP 2 2-4-6-8-10-12mm</p> <p>IDX 14010</p>	<p>Probe CP 2 2-4-6-8-10-12mm Ball end</p> <p>IDX 14007</p>	<p>Probe CP 11 3-5-8-11mm</p> <p>C8 1234 C6 1534</p>	<p>Probe CP 12 3-6-9-12mm Ball end</p> <p>IDX 14009</p>
<p>Probe CP 12 3-6-9-12mm</p> <p>C8 1232 C6 1532 IDX 14006</p>	<p>Probe CP 15 1-15mm North Carolina Probe</p> <p>Pi 1036-15 IDX 14005</p>	<p>Probe CP 18 3-5-8-10mm</p> <p>C8 1275-18 C6 1575-18 Pi 1036-14</p>	
<p>William Probes</p>		<p>William & Explorer holst</p>	
<p>2-4-6-8-10-12mm Single-end</p> <p>C8 1230 C6 1530</p>	<p>3-5-8-11mm Single-end</p> <p>C8 1231 C6 1531</p>	<p>3-6-9-12mm</p> <p>C8 1227 C6 1527</p>	

Handle Option

- C6** 6 mm solid
- C8** 8 mm hollow
- Pi** Premium 10 mm hollow
- Active Explorer 12** 12 mm
- IDX** Ergonomic Silicone 12 mm

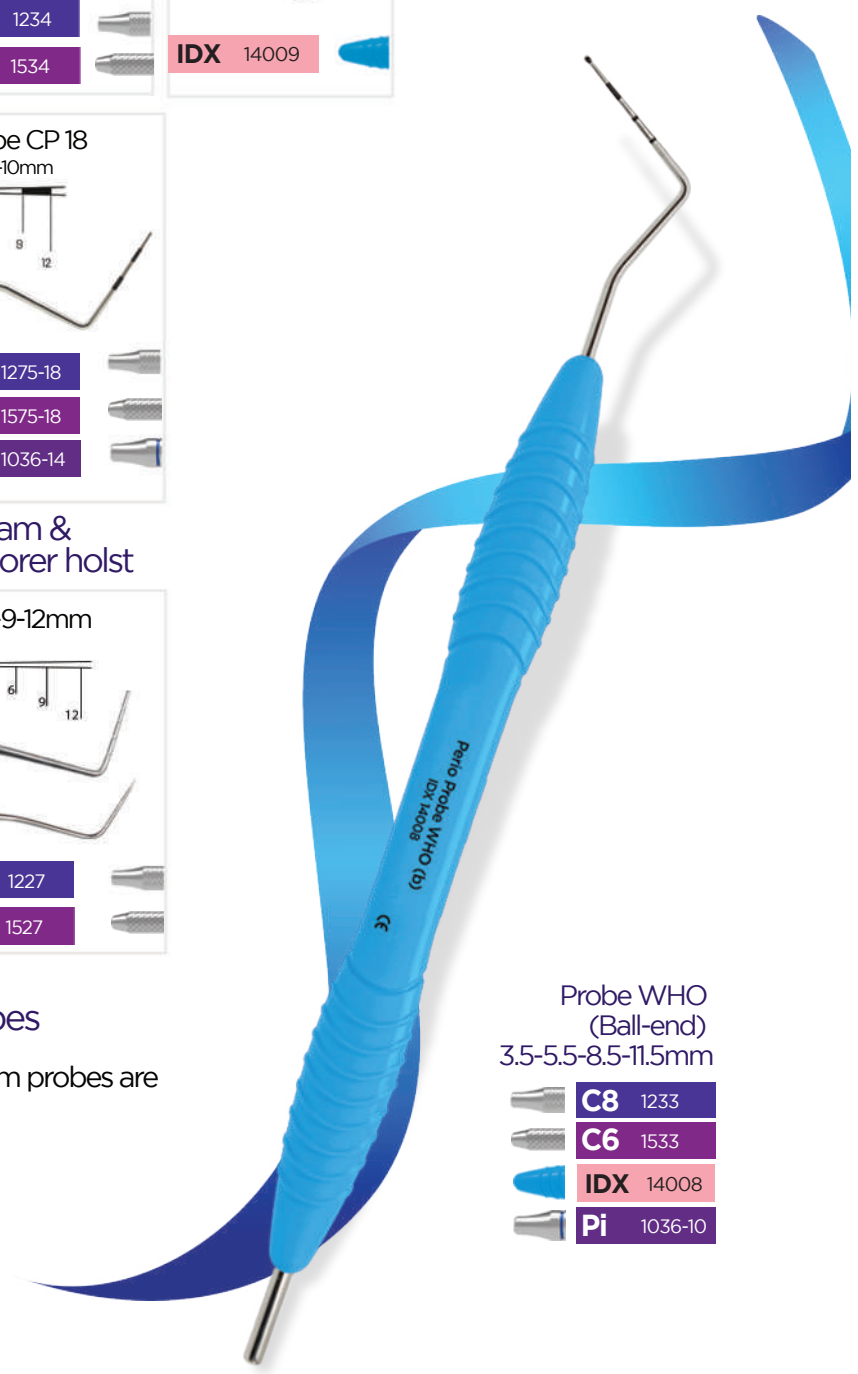

Difference between CP & William probes

The CP probes are color coded, while the William probes are machine-marked and have no color coding.

Probe WHO (Ball-end)
3.5-5.5-8.5-11.5mm

- C8** 1233
- C6** 1533
- IDX** 14008
- Pi** 1036-10

ExPros: Probes + Explorer

A combination of an Explorer & a Perio Probe instrument.

CP-2 2-4-6-8-10-12mm



Probe CP 2 + Explorer 23 (Ball end) **NEW**

IDX 11008 **IDXP** 11008



Probe CP 2 + Explorer 8 (Ball end) **NEW**

IDX 11012 **IDXP** 11012



<p>Probe CP 2 + Explorer 23</p> <p>IDX 11011</p>	<p>Probe CP 2 + Explorer 6</p> <p>C8 1275-26</p>
---	---

Ball-end perio probes

- Helps identifying root unevenness.
- Causes no tissue damage
- Measurement of pocket depth is more precise and accurate.
- Gives information on subgingival calculus.

Handle Option

- C6** 6 mm solid
- C8** 8 mm hollow
- Pi** Premium 10 mm hollow
- IDX** Ergonomic Silicone 12 mm
- IDXP** Ergonomic Plus Silicone 13 mm

CP-18 3-5-8-10mm

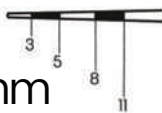

Probe CP 18 + Explorer Holst

Pi 1042-16

IDX 11013

Probe CP 18 + Explorer 9

C6 1575-189

CP-12 3-6-9-12mm



Probe CP12 + Explorer 23

C10 1178-5

Pi 1023-25B

Probe CP12 + Explorer 23

IDX 11007

ExPros: Probes + Explorer

A combination of an Explorer & a Perio Probe instrument.

CP-15
1-15mm

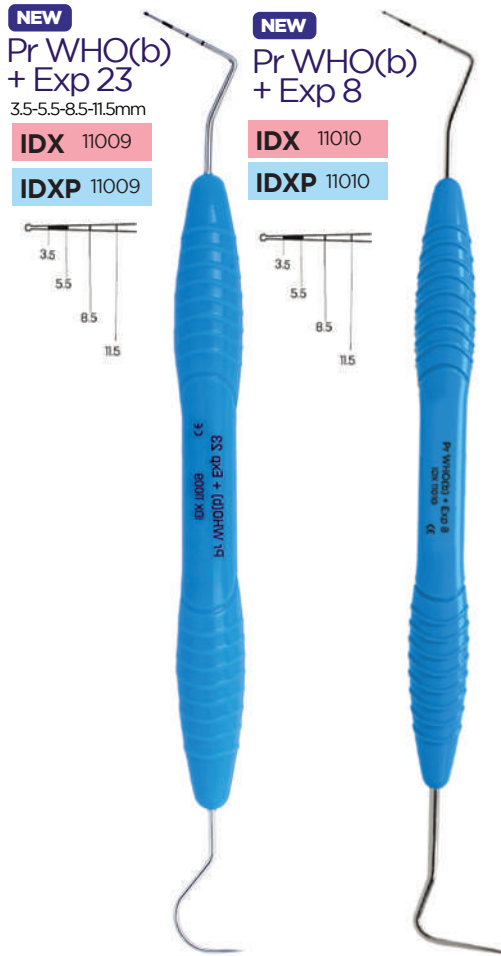
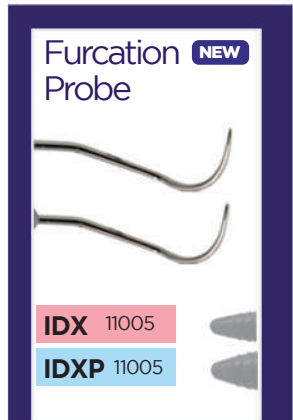
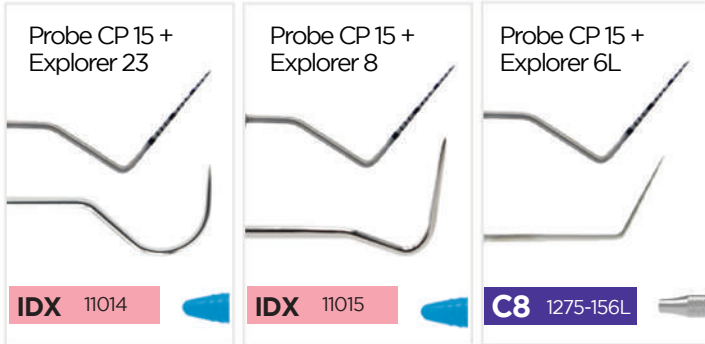
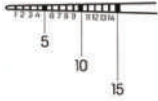

Handle Option

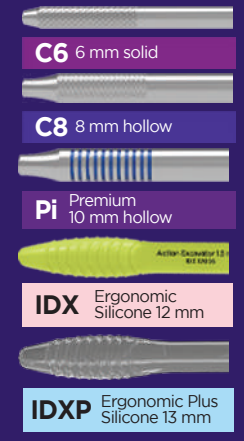

Dr. Ammad Jawed.
MCLINDENT(TRAINEE).
NHS, Cardiff, UK.

As an endodontic trainee I spend long hours holding instruments. The IDX instruments are designed ergonomically and I found them very comfortable to use. All the instruments have textured grips so they don't slip easily and provide better handling. The spoon excavator reaches the deeper parts of the cavity and provides more control in removing caries/debris. The non-stick properties of composite modelling instrument saves a lot of time and effort. These instruments come in different colours which makes it very easy to differentiate in the cassette tray and it reduces the overall working time. The cassette has two locking ends which secures the instruments in place and is fully autoclavable. In a nutshell, I had a very pleasant experience with these instruments and I would definitely recommend them to others.

Dental Mouth Mirror & Mirror Handles

IDX Ergonomics Mirror handles

		Light Pink 11025
		Storm Gray 11024
		Light Green 11023
		Serenity 11022
		Radiant Orchid 11021
		Red 11020
		Special Blue 11019
		Yellow 11018

Plain mouth mirror

12 pcs / Pack

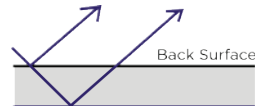

Small 20 mm 1003S
Medium 20 mm 1004S
Large 24 mm 1005S



Front surface mirror

Only one reflection
Exact sharp image
Fully autoclavable
Natural reflection & color

No reflection & no double image

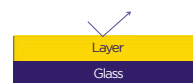

10 pcs / Pack

Small 20 mm 1003F
Medium 22 mm 1004F
Large 24 mm 1005F



<p>6mm solid mirror handle 1526</p>	<p>8mm hollow mirror handle 1226</p> <p>BEST SELLER</p>	<p>8mm hollow mirror handle 1034</p>	<p>Chrome plated mirror handle 1226C</p>
---	--	--	--



Dr. Viola Thomsen

Taastrup, Denmark

The softness, ergonomic grip, and fantastic color selection of the mirror handles are all things I admire. These IDX instruments are extremely comfortable to hold, do not slip, and have very professional and high-quality working points. They have the same feel as any other high-end instrument I've used in the past.

Diagnostic kits

Basic Diagnostic Set IDX 17080

5 instruments and 1 sterilization cassette are included in this simple diagnostic package. Either a Manage-5 (Plastic) or Mini-5 (Stainless-steel) cassette is available with this package.

- IDX 11018 Dental Mirror
- IDX 11002 Explorer 5-9
- IDX 11009 Explorer 23 - Periodontal Probe WHO
- IDX 12001 Excavator 63-64 (1.5mm)
- MA 2271-1 College Tweezer, serreted, 15cm
- IDM 5001 Manage5 (plastic) sterilisation tray



Basic Diagnostic set with small tray (stainless steel)
IDX 17080s



Super Diagnostic kit IDX 17090

9 instruments and 1 sterilization cassette are included in this super diagnostic set (optional to choose from either plastic or metal tray).

- 2270-2 Meriam Tweezer, TC (Tungsten Carbide)
- IDX 11001 | Explorer 23
- IDX 14003 | Explorer 9 (single-end)
- IDX 14006 | Perio Probe CP12 3-6-9-12mm
- IDX 11019 | IDX Ergonomic mirror handle (2 pcs)
- IDX 12017 | Plastic instrument - posterior
- IDX 12016 | Nystrom III
- IDX 12001 | Excavator 63-64 (1.5mm)
- IDM 6004 | Manage-9 Black sterilization cassette



Super Diagnostic Kit with medium tray (stainless steel)
IDX 17090s





Conservative instruments

Rubberdam instruments

Clamps

Matrix retainers

Crown instruments

Composite instruments

Excavators

Excavator

Action
Excavator
1.5 mm

IDX 12005

Action
Excavator 1.5mm
IDX 12005
CE

Spoon
Excavator 17mm
IDX 12009
CE

Round
Excavator
1.5 mm

IDX 12001

Spoon
Excavator,
1.3 mm

IDX 12009

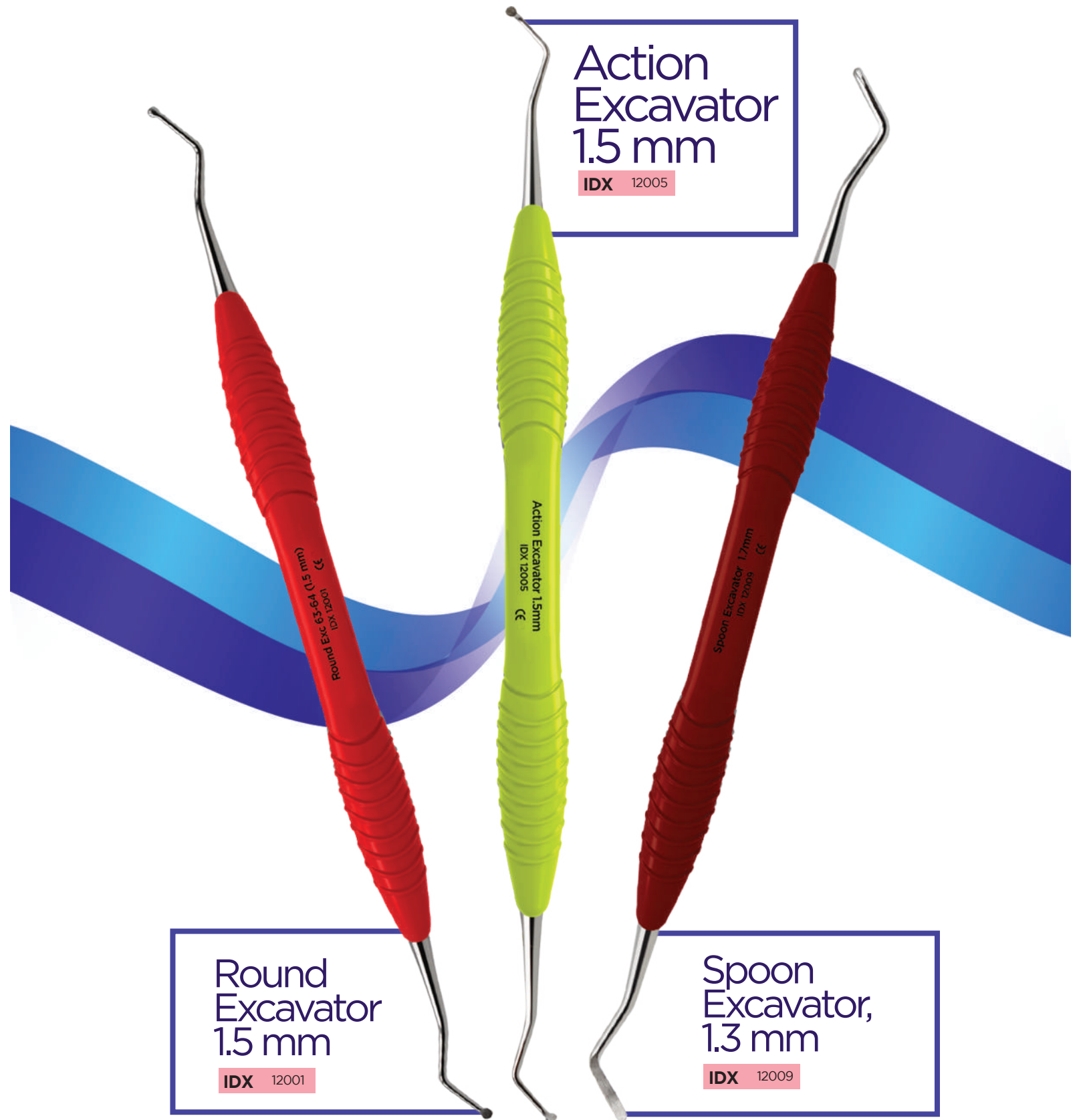

Excavators

Action Excavators

<p>Action Excavator 1.0 mm NEW</p>  <p>IDX 12006 IDXP 12006</p>	<p>Action Excavator 1.5 mm NEW</p>  <p>IDX 12005 IDXP 12005</p>	<p>Action Excavator 2.0 mm NEW</p>  <p>IDX 12007 IDXP 12007</p>
---	---	--

Handle Option

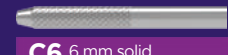

C6 6 mm solid

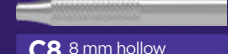

C8 8 mm hollow



Pi Premium
10 mm hollow



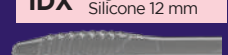

IDX Ergonomic
Silicone 12 mm

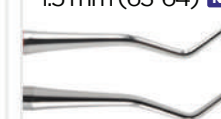

IDXP Ergonomic Plus
Silicone 13 mm

Round Excavators



<p>Round Excavator 1.0 mm (61-62) NEW</p>  <p>IDX 12003 C6 1501 C8 1201 IDXP 12003</p>	<p>Round Excavator 1.5 mm (63-64) NEW</p>  <p>IDX 12001 C6 1502 C8 1202 IDXP 12001</p>	<p>Round Excavator 2.0 mm (65-66) NEW</p>  <p>IDX 12002 C6 1503 C8 1203 IDXP 12002</p>	<p>Round Excavator 2.5 mm NEW</p>  <p>IDX 12004 C6 1504 C8 1204 IDXP 12004</p>
--	--	---	--

Round Excavator
3.0 mm



C6 1505
C8 1205

Spoon Excavators





<p>Spoon Excavator 1.3 mm NEW</p>  <p>IDX 12008 IDXP 12008</p>	<p>Spoon Excavator 1.7 mm</p>  <p>IDX 12009</p>
--	--

Round
Excavator
129/130
Pi 1020

Spoon
Excavator
65/66
Pi 1019

Composite Instruments

Burnisher

<p>Burnisher & Plugger 1.4mm - 1.8mm NEW</p>  <p>IDX 12011</p> <p>IDXP 12011</p>	<p>Burnisher & Plugger 1.9mm - 2.3mm NEW</p>  <p>IDX 12012</p> <p>IDXP 12012</p>	<p>Burnisher NEW</p>  <p>IDX 12013</p> <p>IDXP 12013</p>	<p>Burnisher NEW 1.75-2.25 mm</p>  <p>IDX 12044</p>
---	--	--	--

Handle Option

- C6** 6 mm solid
- C8** 8 mm hollow
- IDX** Ergonomic Silicone 12 mm
- IDXP** Ergonomic Plus Silicone 13 mm

Burnisher & Plugger 1.5mm - 2.5mm **NEW**

IDX 12010 **IDXP** 12010





Burnisher & Plugger 1.5mm - 2mm **NEW**





IDX 12014 **IDXP** 12014

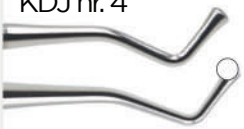

NEW Base Carrier

<p>Base Carrier Rigid</p>  <p>IDX 12040</p>	<p>Base Carrier-Condenser Malleable tip</p>  <p>IDX 12041</p>	<p>Base Carrier-Condenser Rigid</p>  <p>IDX 12042</p>
---	--	---

Plugger

<p>2.0mm- 2.5mm KDJ nr. 4</p>  <p>C6 1514</p> <p>C8 1214</p>	<p>0.7mm- 1.0mm</p>  <p>C6 1515</p> <p>C8 1215</p>	<p>1.0mm - 2.0mm</p>  <p>C6 1508</p> <p>C8 1208</p>	<p>1.0mm - 1.5mm</p>  <p>C6 1506</p> <p>C8 1206</p>	<p>1.0mm - 1.5mm</p>  <p>C6 1507</p> <p>C8 1207</p>
---	---	--	---	--



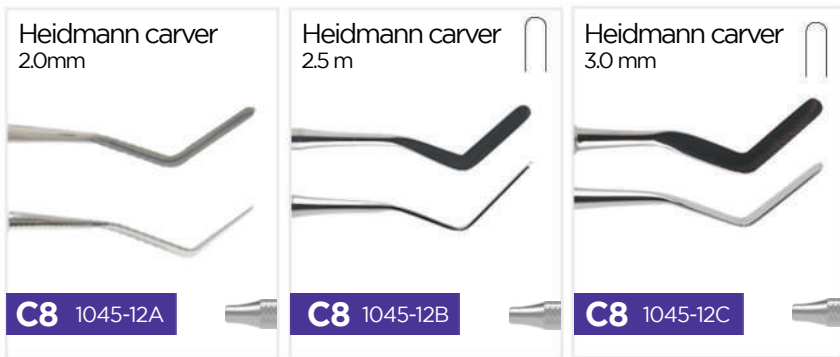

Amalgam stopper

Composite Instruments

Heidmann carver

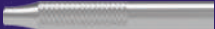

Handle Option

-  C6 6 mm solid
-  C8 8 mm hollow
-  Pi Premium 10 mm hollow
-  IDX Ergonomic Silicone 12 mm
-  IDXP Ergonomic Plus Silicone 13 mm

Special Carver



Carver 5



**Dr. Ivana Vrbić,
Zagreb, Croatia**

My first introduction with MA Dental was while using their IDX ergonomic instruments for composite modelling. They were very comfortable with non-stick properties which helped a lot during procedures. After a while I decided to get their surgical instruments from which I would single out La Grange black scissors and Barraquer gingiva as very precise and durable surgical tool.

Nyström II **NEW**

2.0mm-2.5mm



Nyström I **NEW**



Cord Packer 2.0 mm **NEW**



Cord Packer 2.6 mm

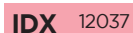

Composite Instruments

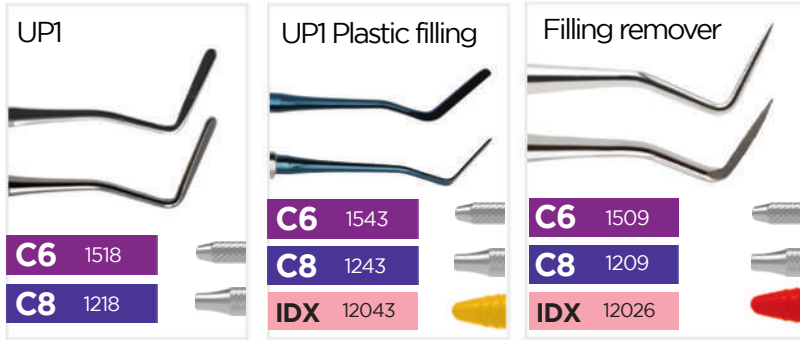

Plastic Instrument (Posterior) **NEW**

IDX 12017 **IDXP** 12017



Plastic Instrument - Anterior **NEW**

IDX 12021 **IDXP** 12021 **C6** 1516 **C8** 1216



Mini Spatula **NEW**

IDX 12018 **IDXP** 12018



Spatula 6 **NEW**

IDX 12020 **IDXP** 12020



Plugger 1.2-2.0 mm

IDX 12039

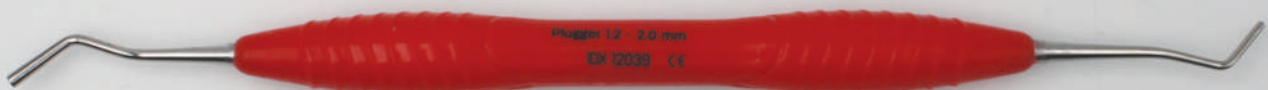

Handle Option

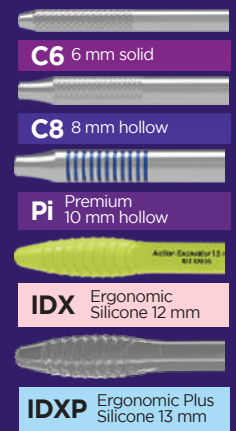

Composite Instruments

Form Condenser | 1.5 - 2.5 mm

IDX 12022



Flow Instrument IO **NEW**

IDX 12023 **IDXP** 12023



GM Trimmer 1.2 mm (Distal)

IDX 12038



GM Trimmer 1.2 mm (Mesial)

IDX 12024



Handle Option



C6 6 mm solid



C8 8 mm hollow



Pi Premium
10 mm hollow



IDX Ergonomic
Silicone 12 mm



IDXP Ergonomic Plus
Silicone 13 mm

Cement Spatel

Cement Spatel

IDX 12025



Cement spatula
5.0 mm



C6 1551-4

C8 1251-4

Cement spatula
6.0 mm



Pi 1092P

Cement spatula
6.0 mm



Pi 1092T

Cement spatula
5.0 mm



Pi 1091

Non-stick composite Instruments

Titanium oxide coating is a highly scratch resistant material applied on the instrument and have a long working life as compared to the non-coated instruments. It has several benefits such as: Its hygiene friendly, easy to clean and its non-sticky surface.

- Hygiene friendly
- Non-stick
- Easy to clean
- Minimal reflection



Burnisher & Plugger **NEW**

IDX 12027 **IDXP** 12027



Plastic instrument (Anterior) **NEW**

IDX 12028 **IDXP** 12028



Universal Spatula **NEW**

IDX 12035 **IDXP** 12035



Plastic instrument (Posterior) **NEW**

IDX 12030

IDXP 12030

Mini Spatula **NEW**

IDX 12029

IDXP 12029

Modeller MH Mini

IDX 12033

Condenser (Drop-shaped) 1.3mm-1.8mm

IDX 12036

Burnisher **NEW**

IDX 12034

IDXP 12034

Modeller MH

IDX 12032

Packer-Modeller IO

IDX 12031



See detail on next page

Non-stick composite Instruments

Handle Option



Filling instrument: C49

Pi 1012



Filling instrument: PFI 8A

Pi 1013



<p>Filling instrument: PFI 6</p> <p>Pi 1014</p>	<p>Filling instrument: UP1</p> <p>Pi 1013-2</p>	<p>Filling instrument: PFI UP1</p> <p>Pi 1022</p>	<p>Plugger 1.8 mm - 2.5 mm</p> <p>Pi 1015</p>
<p>Plugger 2.5 mm - 3.8 mm</p> <p>Pi 1016</p>	<p>Plugger 1.3 mm - 1.8 mm</p> <p>Pi 1017</p>	<p>Plugger 1.0 mm - 1.3 mm</p> <p>Pi 1018</p>	<p>Knife / Carver</p> <p>Pi 1021</p>

All-round non-stick compo set 17081

This all-purpose non-stick compo package is suitable for handling a range of fillings. It is very easy to clean these instruments during operations because of the unique titanium material that has been applied to them. Either a Manage-5 (Plastic) or Mini-5 (Stainless-steel) cassette is available with this package.

- IDX 12035 | Universal Spatula
- IDX 12029 | Mini Spatula
- IDX 12028 | Plastic instrument, anterior
- IDX 12034 | Burnisher
- IDX 12027 | Burnisher & Plugger 1.5 & 2.5 mm
- IDM 5001 | Manage5 (plastic) sterilisation tray



Restoration kits

Compo-5 Set IDX 17082

This is an excellent compo-5 package that will protect the most of your restoration treatments. This Compo-5 kit includes five instruments as well as one sterilization cassette. Either a Manage-5 (Plastic) or Mini-5 (Stainless-steel) cassette is available with this package

- IDX 12022 | Form Condenser
- IDX 12018 | Mini Spatula
- IDX 12021 | Plastic instrument, anterior
- IDX 12023 | Flow Instrument IO
- IDX 13017 | Mini Sickle Scaler
- IDM 5001 | Manage5 (plastic) sterilisation tray



Compo set with small tray (stainless steel)

IDX 17082s



Super Restoration kit IDX 17091

A perfect super restoration kit, complete with diagnostic, composite, and sickle scaler instruments.

- IDX 11018 | IDX mirror handle with mouth mirror
- IDX 12001 | Excavator 1.5mm
- IDX 11007 | Explorer 23 - Probe CP12 3-6-9-12mm (Ball-end)
- IDX 12010 | Burnisher & Plugger 1.5mm - 2.5 mm
- IDX 13018 | Micro Sickle scaler 01-02
- IDX 12018 | Mini Spatula
- IDX 12022 | Flow Instrument IO
- 2270-1 | Tweezer Meriam, 15cm
- 2274 | Tweezer Miller, 16cm



Super Restoration kit (stainless steel)

IDX 17091s

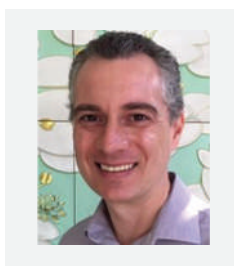

“Dr. Cristian, who has worked in the healthcare sector for over 15 years and is currently the owner/manager of Dental Treatment Clinica Odontologica in Australia, created this Super restoration kit.”

**Super restoration kit by
Dr. Cristian Dunker,
BDS, MBA**

Rubberdam Instruments

Ainsworth



Ivory



17.5cm
5702-2

BEST
SELLER



Rubberdam stand

Small
5711-1



Large
5711-2



Stockes



Washington



Brewer

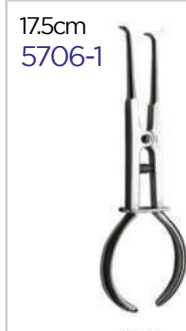

White

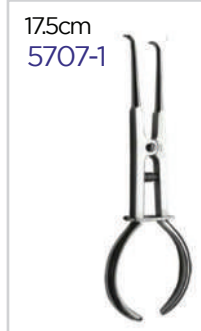

Rubberdam Clamps

Universal
molars



5731-8A



5731-8AD



5731-W8A



5731-10



5731-11



5731-14



5731-14a



5731-w14a



5731-18



5731-24



5731-25



5731-27



5731-56



5731-56S

Premolars



5732-0



5732-1



5732-1A



5732-2



5732-2A



5732-2AS



5732-W2

New!

Rubber-Dam Black

For more details see our website: www.madental.dk

Premolars



5732-27N



5732-29



5732-209

Lower jaw molars



5734-3



5734-W3



5734-7



5734-7A



5734-W7



5734-12A



5734-13A



5734-26



5734-28

Upper jaw



5735-4



5735-w4



5735-5



5735-8



5735-26n



5735-30



5735-31



5735-201



5735-205

Anterior



5733-00



5733-6



5733-9

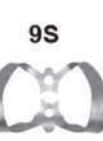

5733-9S



5733-212



5733-212SA

New!

Rubber-Dam Black

For more details see our website: www.madental.dk

Matrix retrainers / holders

Ivory



Tofflemire



Nystorm



Crown instruments

Miller crown remover

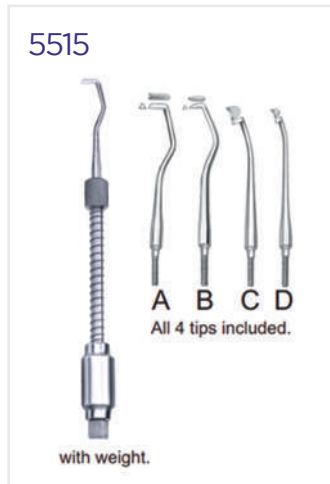

Crown Removers with silicone tips



Crown remover



Crown remover pliers

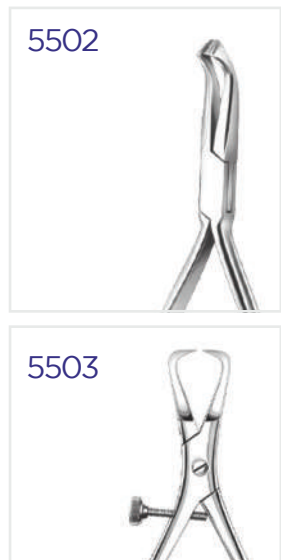

Crown spreader



Scissors



Extraction



Extraction Forceps
Root tip elevators

Extracting Forceps **Diamond**

Diamond coating offers a strong grip on the tooth, and requires less force while extracting

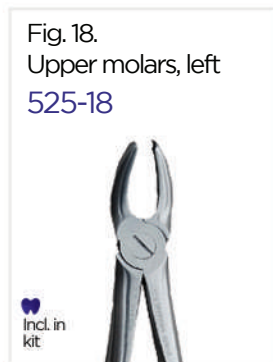
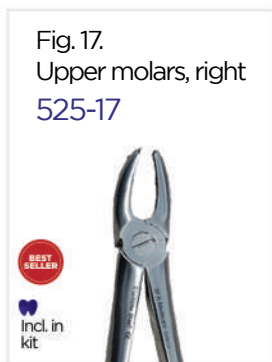
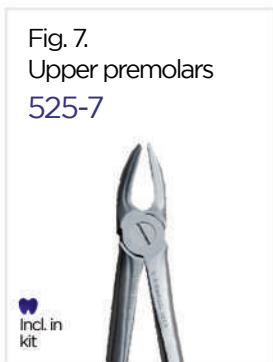

For lower & upper wisdom

Lower roots

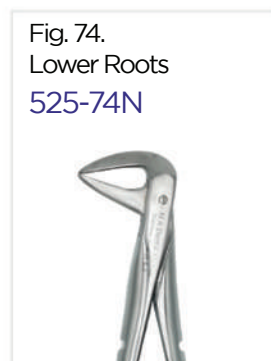

Lower Molars

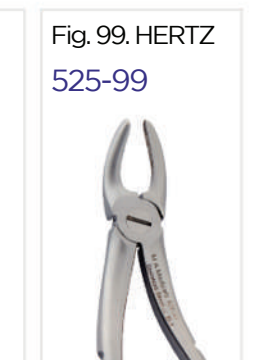
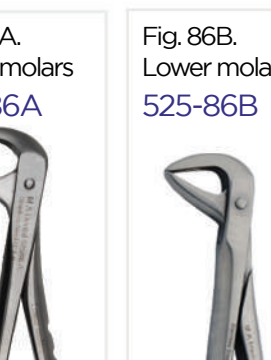
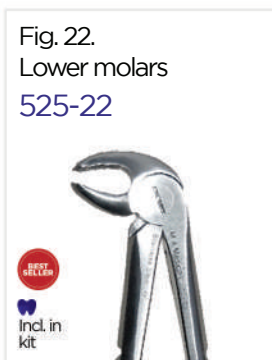

Lower, Upper centrals, canines and premolars

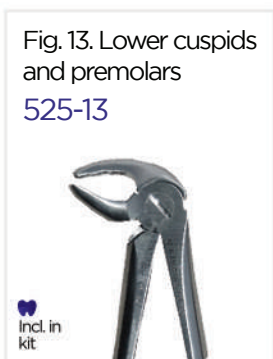

Extracting Forceps **Diamond**

Upper roots



Fig. 144.
Upper Roots
525-144



Fig. 97.
Upper Roots
525-97



Fig. 41.
Upper Roots
525-41



Fig. 30S. **NEW**
Upper Roots
522-30S



Fig. 98. WITZEL
525-98



Fig. 46.
Upper Roots
525-46



Fig. 29.
Upper front
525-29



Fig. 51A.
Upper Roots
525-51A



Forceps kit 525



10 most used
diamond tip forceps
in a kit

Extracting forceps
marked  with are included
in the kit



Extracting Forceps **Regular pattern**

lower & upper wisdom

Fig. 67A. Upper molars -For Upper wisdom teeth
520-67A



Fig. 79. Lower wisdom teeth
520-79



Centrals, canines & lower premolars

Fig. 1. Upper Incisors & cuspids
520-1



Fig. 13. Lower cuspids & premolars
520-13



Lower molars

Fig. 22. Lower molars
520-22



Fig. 23. Lower molars, right
520-23



Fig. 24. Lower molars, right
520-24



Fig. 86A. Lower molars
520-86a



Fig. 87. Lower molars
520-87



Lower & upper roots

Fig. 51A. Upper Roots
520-51A



Fig. 33A. Upper premolars
520-33A



Universal - Lower roots
520-UK



Universal - Upper roots
520-OK



Upper premolars

Fig. 7. Upper premolars
520-7



Fig. 7. Upper premolars
520-17



Fig. 18. Upper molars, left
520-18



Forceps kit 520

11 most used forceps in a kit

Extracting forceps marked  with are included in the kit

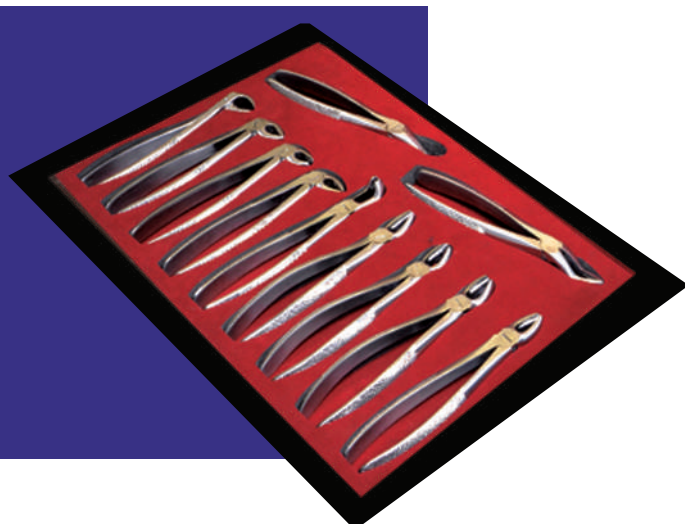

Extracting Forceps for children

Diamond

Upper & lower molar

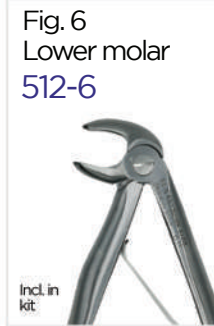

Upper & lower incisivier

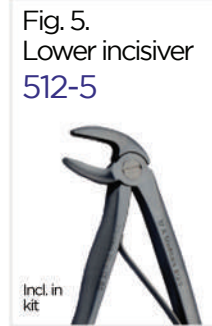
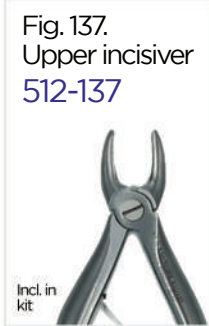

Upper pre molar



Upper & lower roots



Forceps kit 512 BEST SELLER

All 7 forceps are included in the kit

Extracting Forceps for children

Regular Pattren

Upper & lower molar



Upper & lower incisivier



Upper pre molar



Upper & lower roots

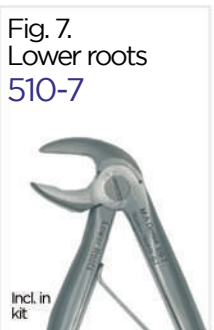

Forceps kit 510 BEST SELLER

All 7 forceps are included in the kit

Extracting Forceps for **Junior**

Junior extracting forceps have shorter working jaws and a shorter

Upper jaw

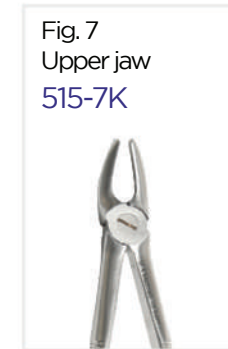
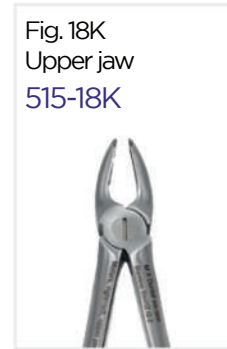
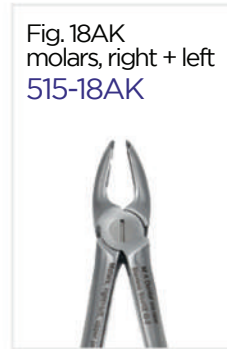
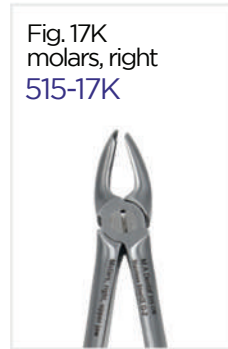
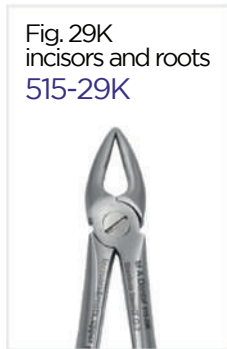

Lower jaw

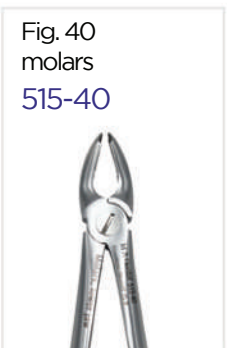
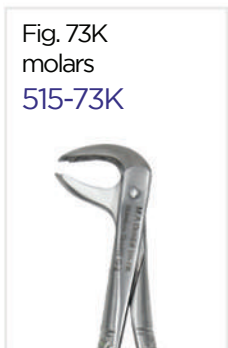
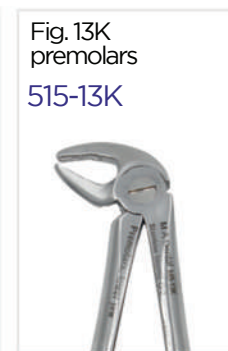
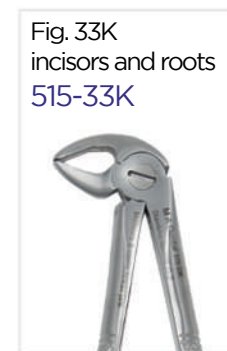
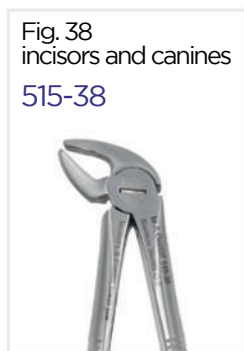

Elevators

Luxating elevators

Straight



Curved



All 8 luxating elevators in a kit
211

Straight



Curved



Elevators - Bein



Bernerd elevators

2127
straight



2128
Angled



Widman knives

1596 **NEW**
curved



1595 **NEW**
straight



Lindo-Levien



Berten elevators



Cryer elevators



2163
Right

2164
left

Appexo elevators

Straight



Curved



Hyllin elevators



Heidbrink (Root tip elevators)

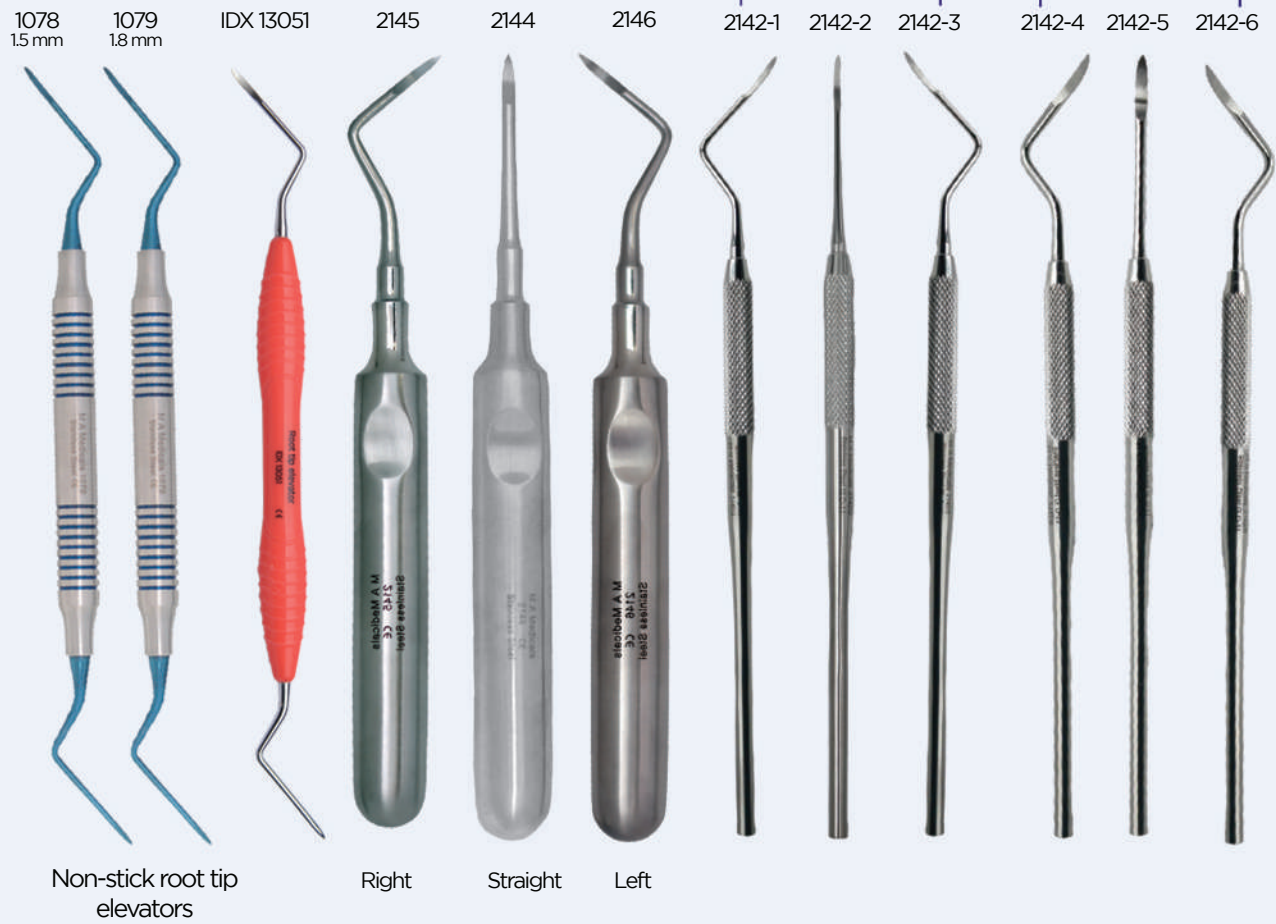

Non-stick root tip elevators

Right Straight Left

Winter



2185-12L Right
2185-12R Left

Appical

2141-3 Right



2141-2 Left



Flohr KOPP

Upper roots

2130-4 Right



2130-3 Left



2124-1 3.6 mm



2124-2 3.6 mm



2124-3 4.2 mm



2124-4 4.2 mm



lower roots

2124-5 4.2 mm



2124-6 4.2 mm



Luxating Elevators

- Fully autoclavable
- Light weight
- Ergonomic handle

All luxating elevators come with a tray.

2101 All 10 luxating elevators kit.



Curved



Duel edge



Contra curved



Straight



Luxating elevator tray

Fully autoclavable luxating elevator tray
Durable material

2102



Available in 2 colors



X tool luxating elevators

Make your tooth extraction hassle free

246

The X tool luxating elevators are perfect for a painless tooth extraction. The working points of X tool luxating elevators are titanium oxide coated and made of solid stainless steel. In contrast to standard elevators, non-stick titanium oxide coating provides minimal reflection during surgery, is hygiene friendly, and has a long working life. Stainless steel is used in the construction of Xtool instruments.

The 7-piece X tool luxating kit comes in a sterilization cassette and is an all-in-one tooth extraction solution that saves time and cost.



2461
Straight



2462
Curved



2463
Spade



2464
Distal



2465
Mesial



2466
Spade



2467
Mesial



X tool - Bernard spade elevators



X tool - Bernard spade elevators

248

The X tool luxating elevators contains Bernard spade and curved elevators. The working points of X tool luxating elevators are titanium oxide coated and made of solid stainless steel. In contrast to standard elevators, non-stick titanium oxide coating provides minimal reflection during surgery, is hygiene friendly, and has a long working life. Stainless steel is used in the construction of Xtool instruments.

The 7-piece X tool luxating kit comes in a sterilization cassette and is an all-in-one tooth extraction solution that saves time and money.





Oral & Micro Surgery

Scissors

Needle holders

Hemostatic Forceps

Tweezers

Retractors

Syringes

Bone Curettes

Periosteal elevators

Orthodontics

Implantology

Endodontic instruments

Scissors

IRIS - Suture scissors

Micro surgery scissors, specially for gums

<p>Straight 11.5cm 15cm 3015 3016</p>	<p>Straight 11.5cm 3022</p>
<p>Curved 11.5cm 3014</p>	<p>Curved 11.5cm 3021</p>

BEST SELLER
TC

La-Grange suture

Double curve

<p>13cm 3013</p>	<p>13cm 3013-1</p>
----------------------	------------------------

TC **NEW**

Spencer - suture

used for trimming tissue or cutting sutures

<p>16cm 3028</p>	<p>16cm 3032-2</p>
<p>11.5cm 3027</p>	<p>14cm 3031-2</p>

TC **TC**

Kelly

Classic suture

<p>Straight 11.5cm 13cm 3018 3017</p>
<p>Curved 11.5cm 13cm 3020 3019</p>

Goldman-fox

Super cut!

<p>Straight 13cm 3025-2</p>
<p>Curved 13cm 3025-3</p>

TC

<p>Straight 13cm 3025-4</p>
<p>Curved 13cm 3025-5</p>

Dressing Scissors

<p>Cooper Scissors 13cm 3029-1</p>

<p>16cm 3026</p>

Angled suture

<p>11.5cm 3023</p>
<p>13cm 3024</p>

Mayo scissors

<p>Straight 14cm 3048-1</p>
<p>17cm 3048-2</p>

TC

<p>Curved 14cm 3048-4</p>
<p>17cm 3048-5</p>
<p>23cm 3048-6</p>

TC

<p>Straight 14cm 3048-1A</p>
<p>17cm 3048-2A</p>

NEW

<p>Curved 14cm 3048-4A</p>
<p>17cm 3048-5A</p>

NEW

Scissors

Metzenbaum scissors

Metzenbaum blunt



Metzenbaum open

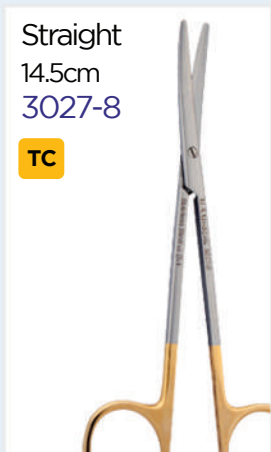

Metzenbaum Fino



Metzenbaum sharp



Kilner



Crown-scissors

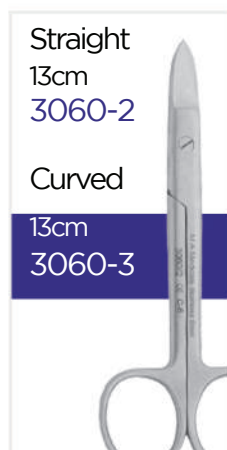

Micro surgery

Quality, precision & micro cut!

Micro surgery

Straight
15cm
3051-1

Curved
15cm
3051-3

TC



Noyes

Straight
15cm
3041-1

Curved
15cm
3041-2

TC



Offset
15cm
3041-3

TC



TC BEST SELLER

Barraquer
/Gingiva

13cm | 15cm
3050 | 3052

Black scissors, Non-stick

MA Dental's black scissors are coated with a special titanium oxide material that keeps the scissor sharp for a long time and provides minimal reflection during surgery. Because of its nonstick properties, it is also easy to clean and very hygienic. These scissors are ideal for use during surgical procedures.

- Minimal reflection
- Perfect for surgery
- Easy to clean
- Stays sharper longer
- Titanium oxide coated



La-Grange suture

13cm
3013B
Double-curve

TC

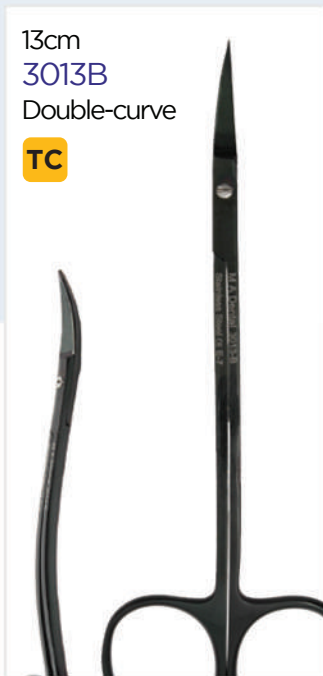

Goldman-fox

Straight
3025SB

Curved
3025CB

13 cm

TC



IRIS - Suture

Straight
3022B

Curved
3021B

11.5 cm

TC



Needle holders

Mathieu needle holders

Straight

14cm
4792-14

17cm
4792-17

TC

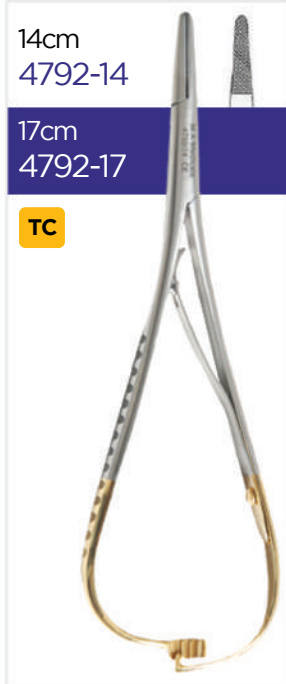

Curved

14cm
4792-14a

17cm
4792-17a

TC

BEST
SELLER



Straight

14cm
4790-14

17cm
4790-17



Curved

14cm
4790-14a

17cm
4790-17a

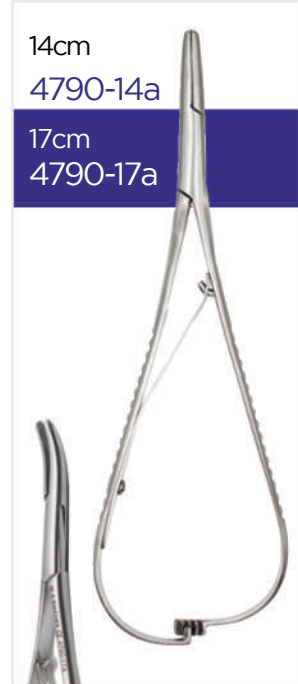

Mathuie-Olsen

17cm
4789-17

With scissor

Hold & cut with
same needle
holder



Lichtenberg

Straight
17cm
4796-17

Curved
17cm
4796-17A

TC



TC

Tungsten Carbide

Tungsten Carbide (TC) is a hard metal that can have a hardness value of 1600 HV whereas mild steel would be in the region of 160 HV a factor of 10 lower. TC enhances the performance of instruments.

All instruments with TC are labeled as "TC".

Needle holders

Castroviejo / Micro needle holders



Crile-wood



Crile-Ryde



Fine-Swedish



Mayo-Hegar



13cm
2605-13A



Crile-wood



Hemostatic forceps

Halstead-Mosquito

Straight
10cm 2701-10 12cm 2701-12 14cm 2701-14

Curved
10cm 2701-10A 12cm 2701-12A 14cm 2701-14A



Classic pean

Straight
13cm 2615 16 cm 2616

Curved
13cm 2615-1 16cm 2616-1



Allison

15cm 2715-15

14cm 2710-14



Kelly

Straight
14cm 2705-14

Curved
14cm 2705-14a



Kocher

Straight
13cm 2704-13 16 cm 2704-16

Curved
13cm 2704-13A 16cm 2704-16A



Stieglitz

Straight
13cm 2702-14A

Curved
13cm 2702-14



Crocodile forcep

13cm 2703-16

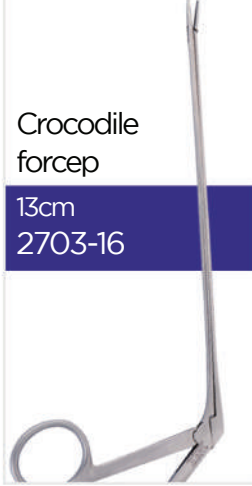

Adson

Straight
18cm 2709-18

Curved
18cm 2709-18a



Backhaus

9cm 2652-9

11cm 2652-11



Tohoku

NEW
10 cm 2714-10



Gemini

Curved
18cm 2708-18A



Hartmann

Straight
10cmt 2703-10

Curved
18cm 2703-10a



Tweezers

Adson

Flagg



Perry

Miller

College

Surgical



Meriam

Anatomic

Taylor



Tweezers

Semken



Crane-Kaplan

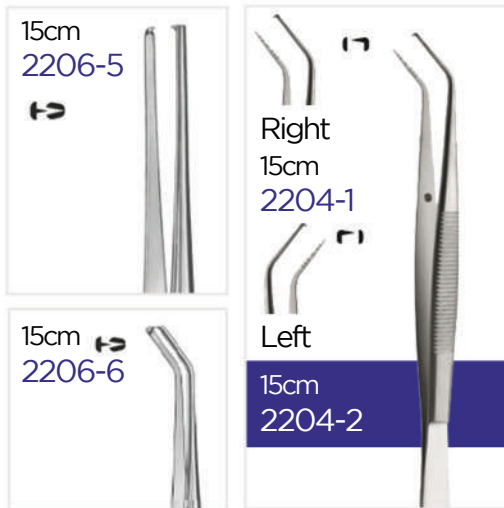

DeBakey

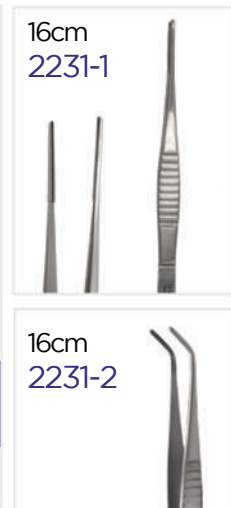

Gerald

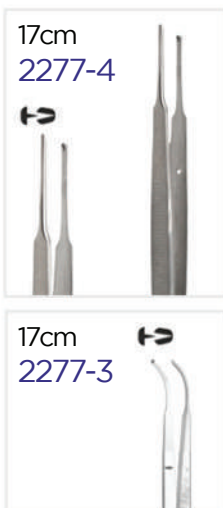

Micro surgical



Endo-Tweezers



Dr. Matini Seresht

Børkop tandlægerene |
Børkop, Denmark

I've been using MA Dental instruments for the past 6 years and have been very pleased with the quality and variety of instruments available. MA Dental instruments are extremely comfortable in the hands, almost as if they were an extension of the surgeon's hands. They are ideal tools for me. That is why I strongly recommend that others use these dental instruments.

Lip, cheek and mouth retractors

Langenbeck



Sean-Miller



Wassmund



Middeldorp



Bowdlerhenry's



Universal cheek retractors



Obwegeser (Internal)



Obwegeser (External)



S-retractor



Bruenings



Gutta-Percha Remover **NEW**

A .06mm micro retrieval hook secures and removes gutta-percha from all canal walls, safely protecting the remaining dentin.



Classic instrument

8 mm hollow light-weight handle

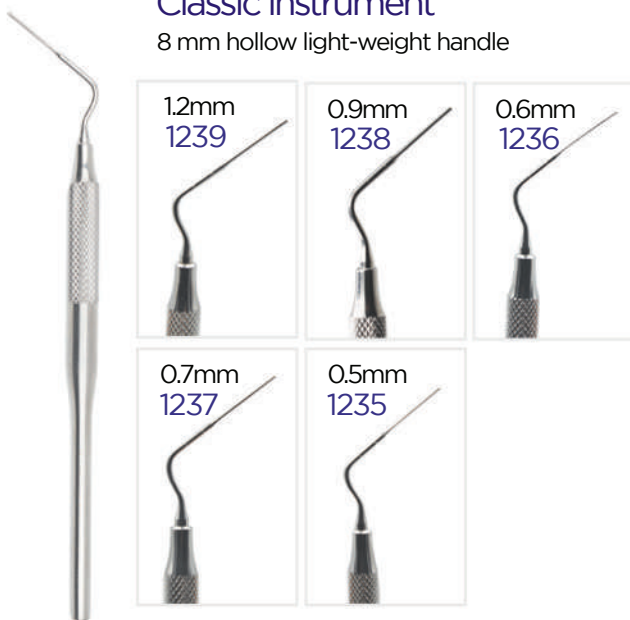

Classic instrument

6mm solid steel handle instrument

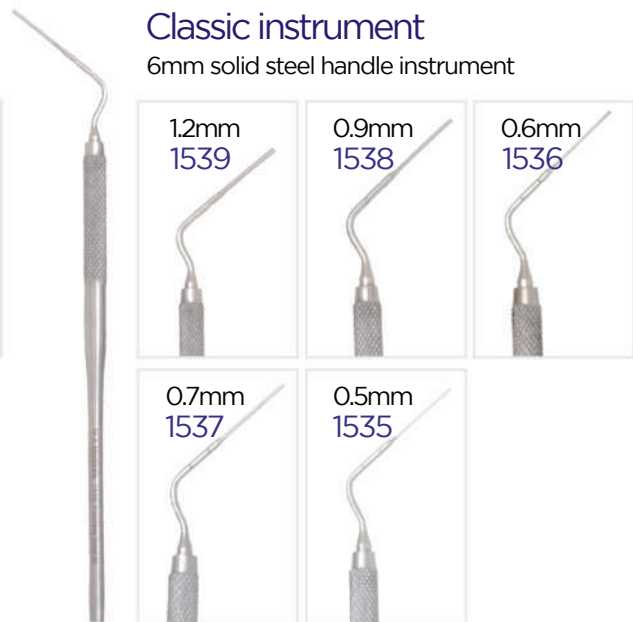

Endo (channel) spreader

1580S Get all 7 spreader & save cost



Endodontics

Endo file holders, forceps and tweezers



NEW
Endo Plugger
IDX 11017
IDXP 11017



NEW
Root Canal Explorer
IDX 11016
IDXP 11016

Endo Explorer
Pi 1040-3



Endo File Forceps
4618



File holder

The file can be held and surrounded securely by the jaws of the file-holder forcep

4615

Can cover the 270° area

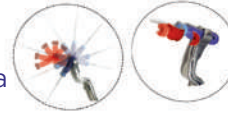

Steiglitz Endo File Forceps

Available in 3 sizes

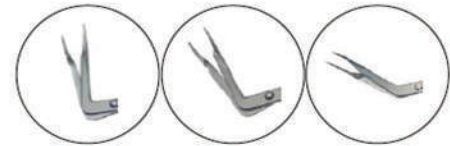

90° Endodontic **4616-1**
75° Endodontic **4616-2**
45° Endodontic **4616-3**



Endo-tweezers

With lock
4621



2274-5



4620



Bur Holder

Following bur holders can hold 4, 8, 12 burs, suitable for any size of FG or latch type. Colored silicone holders can be replaced and provides easy organization.

For 4 bur holders
4671



For 8 bur holders
4673



For 12 bur holders
4675



4676B
4676R
4676Y
4676G



Orthodontics

Pin and ligature cutter

Wire cutter

13cm
5901-6
Max Ø: 0,7mm



13cm
5901-4
Max Ø: 0,5mm



13cm
5901-6A



Distal end cutter Wire cutter forceps

13cm
5902-1
Max Ø: 0,5mm -
0,64 mm



15cm
5906-4
Max Ø: 1,0mm



12cm
5906-3
Max Ø: 0,6mm

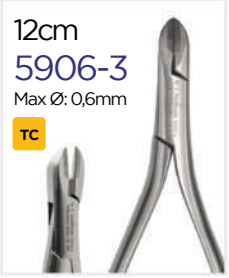

12cm
5906-3A
Max Ø: 0,6mm



Nose-pliers

5920-1
Short



5920-2
Long



Universal plier

5624



Aderer

Short
12,5cm
5907-1



Long
13cm
5907-2

Weingart

5625



5625A



Schwarz

5910-1
Max Ø 0,4mmt



Adams

5910-2
Max Ø 0,4mmt



Tweed

12,5cm
5905-5
Max Ø 0,5mm
Short



Angle

12,5cm
5904-1
Max Ø 0,5mm



12,5cm
5904-3
Max Ø 0,5mm



Orthodontics **NEW**

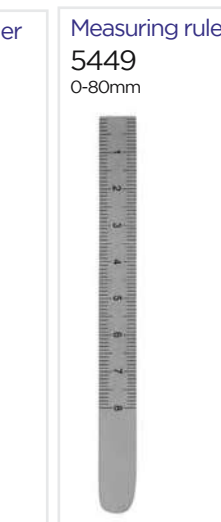
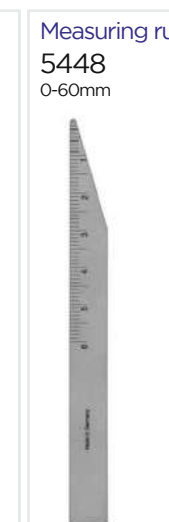
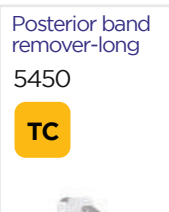

For more ortho instruments please visit our website www.madental.dk

Implantology

Sinus lift instruments



Kramer-Nevin

Used during a sinus lift procedure to separate/reflect the Schneiderian membrane from the maxillary bone and to elevate the membrane.

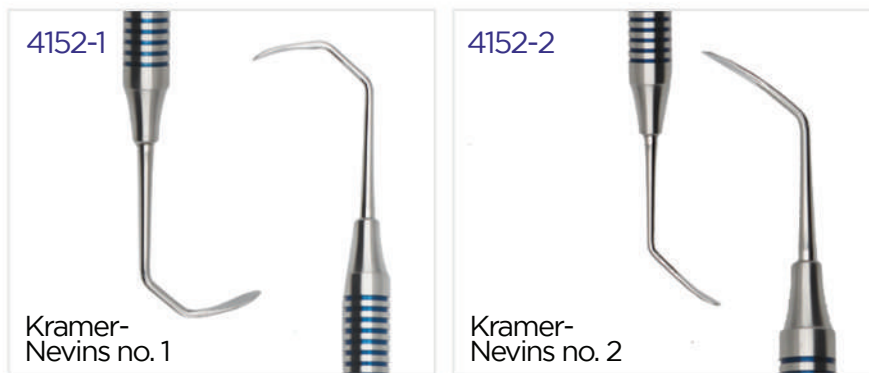

Sinus lift elevators / instruments



Implantology

Professionally crafted quality implant instruments

Bone Splitting instruments

straight



Curved



Implantology

Osteotome
Straight

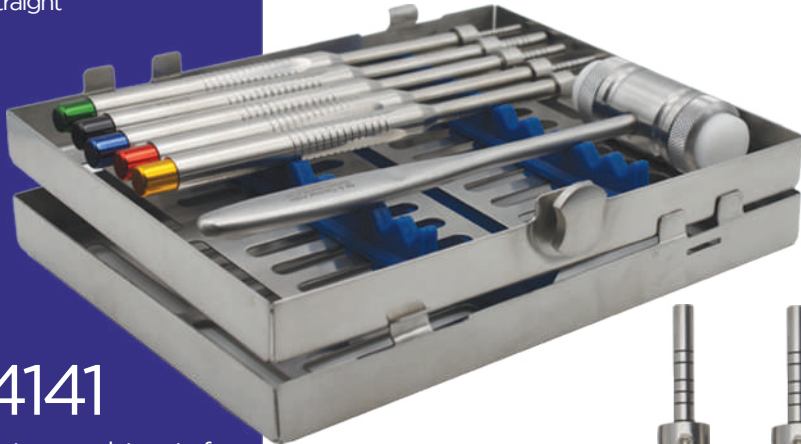

4141

Get a complete set of Osteotome (straight) with tray & hammer



Condenser kit is designed & aligned in such a manner that the tip of the following condenser instruments fits in the bone cavity created by the previous condenser instrument. This ensures safe depth-gauging and conforms to the regular implant lengths.

4140



Get a complete set of Osteotome (offset) with tray & hammer

Off-set



Implantology

4131 Condenser



a5mm - b5.7mm



a3mm - b3.7mm



a4.5mm - b5.2mm



a2.5mm - b3.2mm



a4mm - b4.7mm



a2mm - b2.7mm



a3.5mm - b4.2mm



A	B
2 mm	2.7 mm
2.5 mm	3.2 mm
3 mm	3.7 mm
3.5 mm	4.2 mm
4 mm	4.7 mm
4.5 mm	5.2 mm
5 mm	5.7 mm

Get a complete set of condenser (straight) with a tray & hammer

4-6-8-10-13-15-18 mm
Set 1 straight

Condenser kit is designed & aligned in such a manner that the tip of the following condenser instruments fits in the bone cavity created by the previous condenser instrument. This ensures safe depth-gauging and conforms to the regular implant lengths.



4134

Get a complete set of condenser (offset) with tray & hammer

Off-set

a2mm - b2.7mm



a3.5mm - b4.2mm



a3mm - b3.7mm



a2.5mm - b3.2mm



a5mm - b5.7mm



a4.5mm - b5.2mm



a4mm - b4.7mm



Set 2 Curved
8-10-13-15-18 mm

A	B
2 mm	2.7 mm
2.5 mm	3.2 mm
3 mm	3.7 mm
3.5 mm	4.2 mm
4 mm	4.7 mm
4.5 mm	5.2 mm
5 mm	5.7 mm

Implantology

Bone Spreader



4138

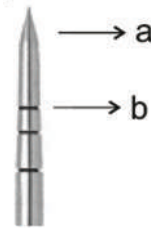

A	B
1.6 mm	1.6 mm
1.6 mm	2.2 mm
2.2 mm	2.2 mm

Hammers

18cm
4161
Ø26mm

4161-1
Accessories
of Spare jaws

Spare jaws for
mead mallet

Teflone hammer with
exchangeable jaws. Fully
autoclave and steriliseable.

17cm
4162
Ø20mm

Solid head 20mm

19cm
4163
Ø19mm

Solid head 19mm

Implant currettes and scalers

1076

M23

986-34
Columbia:
13/14

986-H6-H7
H6-H7 -
Sharp knife

Implantology

Perforated impression trays

Lower jaw

Extra Small
8001-1

Small
8001-2

Medium
8001-3

Large
8001-4

Extra Large
8001-5



Upper jaw

Extra Small
8002-1

Small
8002-2

Medium
8002-3

Large
8002-4

Extra Large
8002-5



8001
Get all 10 upper & lower perforated impression trays in a kit



Non-perforated impression trays



8011
Get all 10 upper & lower non-perforated impression trays



Upper jaw

Extra Small
8011-1

Small
8011-2

Medium
8011-3

Large
8011-4

Extra Large
8011-5



Lower jaw

Extra Small
8012-1

Small
8012-2

Medium
8012-3

Large
8012-4

Extra Large
8012-5



Half perforated impression trays

Right
8003-2

Left
8003-1



Half Non-perforated impression trays

Right
8013-2

Left
8013-1



Injection Syringes

Pen model intraligamental syringe

Three removable parts



6000-11

Autoclaveable up to 134°C
Great control on injection
High quality interligamentations syringe

Offset/curved
For Upper
& lower jaw



6000-16

Offset/curved model can be used in upper jaw & lower jaw.

Syringe holder



6009-1

Cartridge syringe, metric

6006
2.2 ml



6005
2.2 ml



6002-1
1.8ml



6002-1B
2.2ml

Self-aspirating

6003-1
1.8ml



6003-1B
2.2ml

6002-2
1.8ml



Pen model intraligamental syringe

6000
0.20 ml per click



Dr. Cristian Dunker,

BDS, MBA | Gold coast, Australia.
"I'd like to share my experience with the MA Dental and IDX instruments. My experience with MA Dental's instruments has been extremely positive. We have complete cassette systems, as well as various kits for restorations, diagnostics, and surgery. I haven't noticed any issues with the IDX instruments or any rust on them. I am extremely pleased and intend to purchase additional instruments. Thank you, MA Dental, for the excellent quality you provide."

Bone curettes

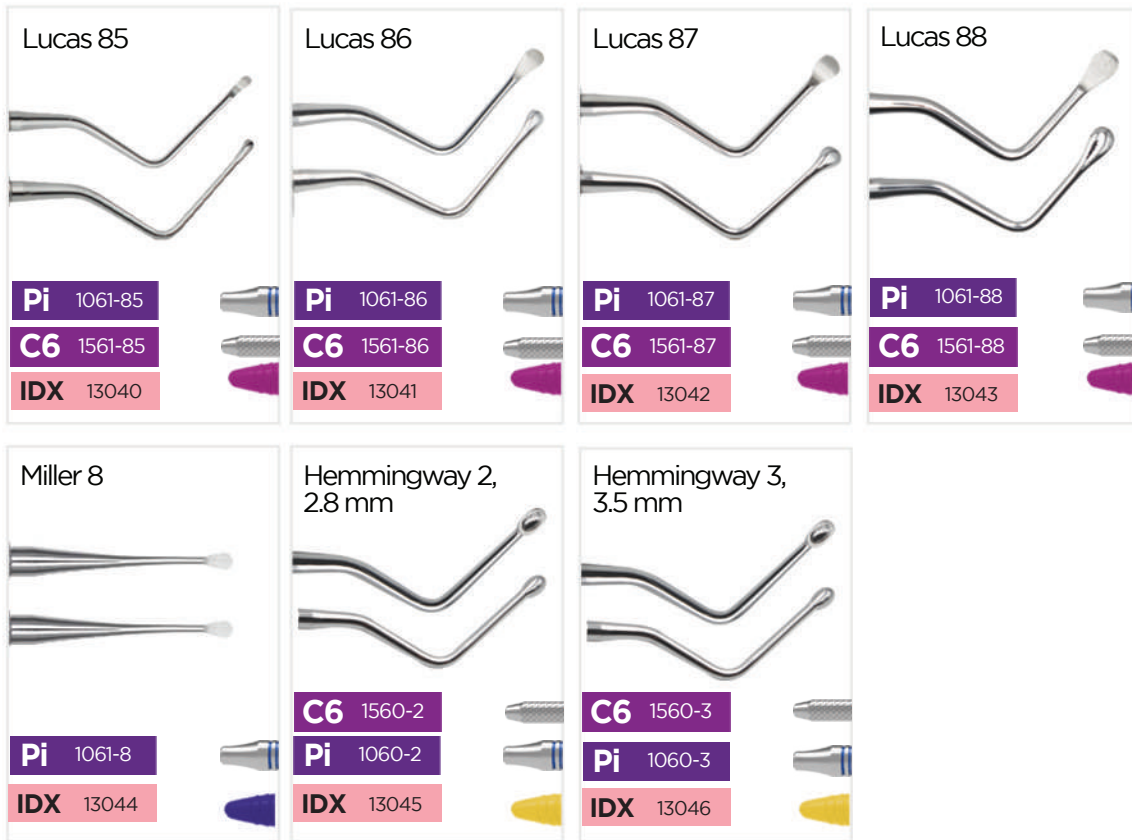

Lucas 84

Pi 1061-84 **C6** 1561-84



Non-stick bone curettes

Miller 8

Pi 1024-85



Lucas: 86

Pi 1024-86



Lucas: 87

Pi 1024-87



Lucas: 88

Pi 1024-88



Periosteal Elevators



Nordborg / Molt

C6 1580-8 **C8** 1280-8 **Pi** 1062



Periosteal elevator

Pi 2147



Williger straight - 16cm

2150



Non-stick Periosteal Elevators

Easy to clean - Minimal reflection - Hygiene friendly

Glickmann

Pi 1064 **C6** 1564 Without coating



Stump - Freer

Pi 1065



Prichard

Pi 1067 **C6** 1567 Without coating



Bone instruments

Bone Forceps

Friedmann

Friedmann Mini



Miller 21

Pi 1072



Bone scrapper
5mm - 3mm

Pi 1069



Periotome

Periotome 2

IDX 13053

Curved / Curved



Periotome 1

IDX 13052

Curved / Straight



Periotome

Pi 1047

Curved / Straight



Periotome

Pi 1048

Curved / Curved



All round surgery kit

This surgery kit is an all round kit which covers most of the instruments required under regular dental surgeries. The surgery kit comes with a sterilisation tray.

15 instruments + 1 sterilisation cassette

- 2271-1 - College tweezer, 15cm
- 2275 - Adson surgery tweezer (1x2), 12cm
- 1613 - Sterilization cassette for 20 instrument with removable top
- 3025-cb - Gold-man fox black scissor Curved 13cm - TC
- 1079 - Root tip elevators 1.8mm, titanium coated instrument
- 2471 - Langenbeck retractor, medium size 42x10mm (21cm)
- 1209 - Filling remover (8mm handle)
- 1062 - Molt 5mm/8mm, periosteal elevator
- 1178-5 - Probe CP-12, 3-6-9-12mm / Explorer 23 (Hollow handle Ø10mm)
- 1076 - Universal curette M23, titanium coated instrument
- 2611 - Crile wood needle holder, 15cm - TC
- 2615-1 - Classic pean, curved, 13cm
- 1028 - Scalpel handle
- 1034 - Mirror handle, titanium coated, hollow-8mm
- 1001F - Rhodium/Front Surface Mirror Ø22mm - no. 4
- 1061-85 - Lucas 85



"In collaboration with MA Dental we managed to assemble a surgical kit that meets the need of any operatory dedicated to oral, implant or perio surgery. Durable - light - versatile. "

Dr. Jerko Rebić
Croatia.

9005



Micro surgery kit

This all-round micro surgery kit covers most of the instruments required under micro dental surgeries. The surgery kit comes with a sterilisation tray.

- 1613 - Sterilization cassette for 20 instrument with removable top
- 3013B - La-Grange suture scissor, black titanium coated, 13cm - TC
- 3052 - Barraquer / Gingiva scissor, 15cm - TC
- 1280-4 - Buser, periosteal elevator
- 1280-6 - Zucchelli, periosteal elevator
- 2652-18 - Castroviejo needle holder, 18cm - TC
- 2209-1 - Micro surgery tweezer, 18cm (1x2)
- 2209-3 - Micro surgery tweezer, 18cm, anatomic
- 1028 - Scalpel handle
- 1034 - Mirror handle, titanium coated, hollow-8mm
- 1001F - Rhodium/Front Surface Mirror Ø22mm - no. 4
- 1061-87 - Lucas 87
- 1062 - Periosteal elevator, Molt (Nordberg)

9010



Periodontal Surgery kit

This periodontal surgery kit is an all round kit which covers most of the instruments required under periodontal surgeries. This periodontal surgery kit comes with a sterilisation tray.

20 instruments + 1 cassette

- 2275 - Adson surgery tweezer (1x2), 12cm
- 1055-15 - Kirkland, titanium coated
- 1047 - Periotome, straight/curved
- 1048 - Periotome, curved/curved
- 1642 - Multi-instrument tray with clips, Large
- 3014 - IRIS suture scissor, curved, 11.5cm
- 2416-4 - Minnesota
- 1064 - Glickmann, titanium coated, periosteal elevator
- 1062 - Molt 5mm/8mm, periosteal elevator
- 1076 - Universal curette M23, titanium coated instrument
- 982-12 - Gracey curettes, 1 / 2
- 982-1112 - Gracey curettes, 11 / 12
- 982-1314 - Gracey curettes 13 / 14
- 2652-18 - Castroviejo needle holder, 18cm - TC
- 2611 - Crile wood needle holder, 15cm - TC
- 1030-2 - Scalpel handle
- 1178-5 - Probe CP-12, 3-6-9-12mm (Hollow handle Ø8mm) Single-end
- 1034 - Mirror handle, titanium coated, hollow-8mm
- 1001F - Rhodium/Front Surface Mirror Ø22mm - no. 4
- 1024-87 - Lucas 87
- 1024-88 - Lucas 88

9015

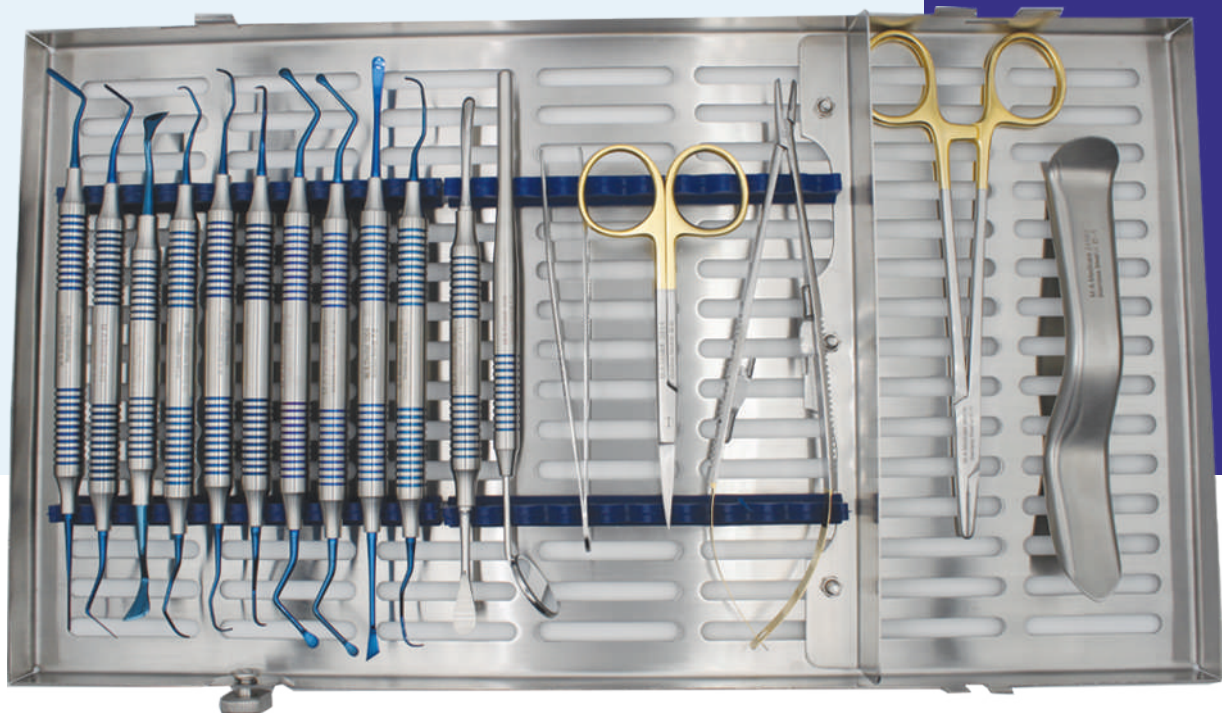



Diverse

Sterilization cassettes

Trays & accessories

Scalpel, rulers

color-coded rings

Sterilizations Cassettes

Wide range of quality sterilization trays

Manage Cassettes

Manage cassettes are made of durable plastic to ensure that instruments are handled safely and efficiently. Cassettes are available in two different sizes and four different colors. The use of different colors makes it simple and convenient to manage dental instruments. The cassettes are light and strong, making them long-lasting. The cassette's ergonomic design makes it easy to use during and after dental procedures. Injury risk is reduced thanks to the top and bottom layers of safety protection. The cassettes' unique design allows for free rotation of the instruments during the autoclave, allowing for thorough cleaning and rinsing of the dental instruments.

Features



Manage-5

182 x 85 x 30 mm



IDM 5001



IDM 5002



IDM 5003



IDM 5004

Manage-9

182 x 140 x 30 mm



IDM 6001



IDM 6002



IDM 6003



IDM 6004



Dentist
Zoya El-Niggar
Glentevej-
Tandklinik, Køge,
Denmark

DENTIST REVIEWS & FEEDBACK

Manage cassettes are of high quality, they look solid & stable. I have sterilized them with & without sterilization bag and they work very well. I really like the different colors which these trays comes in and their practical sizes for regular dental procedures. The various colors helps identify and manage the different procedural trays easily, like regular diagnostic or filling treatments".

Sterilizations Cassettes

Stainless Steel Sterilization Cassettes

Stainless steel cassettes are rust-free. The detachable-lid design allows for better instrument visibility, as well as saving space within the cassette, easy handling, and open/close functionality. Fully autoclavable and capable of disinfection as well as sterilization in a single cassette. Our trays are available in three different colors for easy identification: red, blue, and green.

Features

<p>Detachable lid & anti rust</p> 	<p>Easy access, space saving & quick handling</p> 	<p>Disinfection in a single tray and sterilization</p> 	<p>Great visibility of the instruments</p> 	<p>Reduced risk of injury & procedure time</p> 	<p>Adjustable silicone</p> 
---	---	--	---	--	--

- 1612
 - **Medium tray for 10 instruments**
 -
- H:35mm X W:145mm X L:185mm



- 1611
 - **Small tray for 5 instruments**
 -
- H:35mm X W:73mm X L:185mm



- 1613
 - **Large tray for 20 instruments**
 -
- H:35mm X W:180mm X L:280mm



Sterilizations Cassettes

Simplify and reduce instruments processing time
Disinfect & sterilization of instrument in one tray

Standard sterilization trays

**For 5
instruments**

1631

Length: 18.7 cm
Width: 6.9 cm
Height: 2.3 cm



**For 7
instruments**

1632

Length: 18.7 cm
Width: 9.2 cm
Height: 2.3 cm

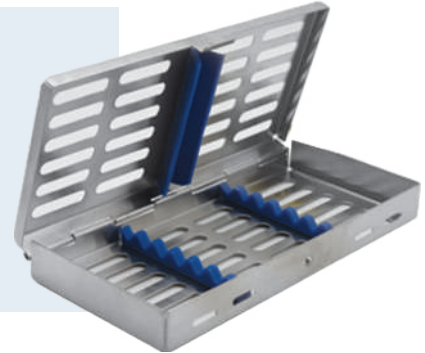

**For 10
instruments**

1633

Length: 18.7 cm
Width: 13.2 cm
Height: 2.3 cm

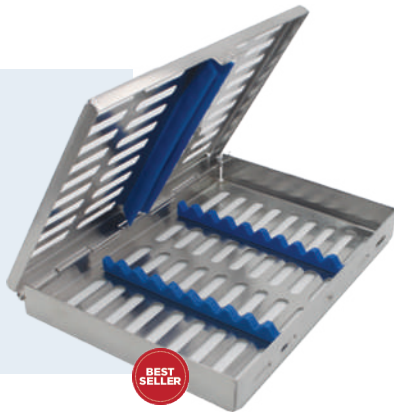

**For 20
instruments**

1634

Length: 28 cm
Width: 18.4 cm
Height: 2.8 cm

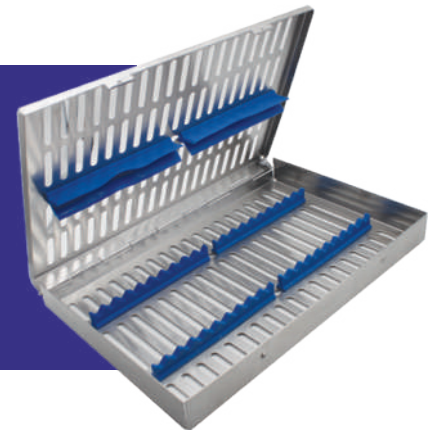

Multi-instrument tray with clips

Ideal for extraction or oral surgery kits

Ideal sterilization trays for sterilizing a variety of instruments in one tray, such as scalars, forceps, elevators, and needle holders. Clips can be used to hold instruments such as scissor and needle holder in place. Streamline your surgery kit by disinfecting and sterilizing instruments in the same tray.

Optimize your work through multiinstrument tray



1642
Large
32x20.5x37 cm



1641
Medium
32x20.5x28 cm

Diverse instruments trays

Solid base tray

3526
18x28 cm



Perforated base tray Tweezer / instrument holder

3525
18x28 cm



5 x 10 cm | Mini
4085
5 x 17 cm | Small
4086
7.5 x 19 cm | Medium
4087
9 x 21 cm | Large
4088

Forceps jar

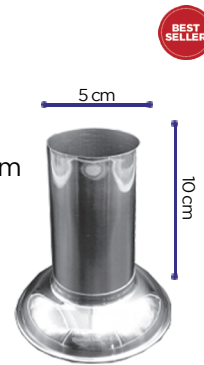

Instrument box with lid Kidney shape

3509



3505



Bowls / pots

4071
Ø 5.5 cm (65ml)
4072
Ø 6.5 cm (130ml)
4073
Ø 7 cm (190ml)



4081
Ø 7cm (90ml)
4082
Ø 9cm (180ml)
4083
Ø 11cm (360ml)



Instrument tray

3527



Shallow (Mayo)

3530



Scaler tray

3531



Perforated tray

3539
18x28 cm



Cathetar tray

3532



Instrument tray with lid

3528



Round box with lid

120x120mm
Fully autoclavable
Stainless steel
4091



Glass

18cl
Fully autoclavable
Stainless steel
4090



Diverse accessories

Color-coded rings

12 colors with dimensions of 4.2 x 6.5 x 3.2 mm for easy instrument identification and organization. Cold sterilization or autoclaving are both options.

<ul style="list-style-type: none">  IDX 7001 blue  IDX 7002 green  IDX 7003 orange  IDX 7004 red  IDX 7005 yellow  IDX 7006 black  IDX 7007 white  IDX 7008 brown  IDX 7009 lavender  IDX 7010 pink  IDX 7011 dark grey  IDX 7012 lime 	
--	--

50 pcs / pack

Rulers Scalpel

Single-use, non-sterile
12 pcs per pack

	
2151-1 10 mm	2151-2 15 mm

Scalpel handles

		
180° 1030	NO:3 1028	1030-2

Napkin holderv

NEW Approx 44cm 3560

Calipers

Beerendonk

3561 130 mm

Zuricher

3562 130 mm

Boley

3563 145 mm

Sliding caliper

3564 125 mm

Iwanson

3565 100 mm

Maintenance

Instructions for cleaning & sterilization of dental instruments

MA Dental has prepared an instruction guide of how to clean & sterilize dental instruments step by step. The process is divided in different steps and the details of each one are described below:

Inspection

While the instrument blades and handles are still soft, make sure to remove any residue. Avoid using a metal brush. A metal brush will leave scratches or scrapes on the instrument surface, allowing residue to attach to other areas of your instruments. Because this is normally difficult to avoid, be mindful that if it is not removed during sterilization, it may bake onto the handle, producing discoloration if not removed.

NOTE: To avoid damaging the coating and thereby shortening the product's lifetime, do not use any abrasive equipment to remove residue from IDX Sharp or non-stick instruments.

DISINFECTION

Do not leave used instruments to sit in water or air. Immediately proceed to wash with your disinfectant of choice for dental hand instruments. Do NOT use liquids that contain chlorine, phenol or amines. Change the disinfectant regularly according to the instructions.

RINSING

The instruments must be washed thoroughly under running, lukewarm water immediately after disinfection.

CLEANING

The cleaning of dental instruments and materials is nothing more than the removal of the dirt, reducing the microbial charge, the organic matter and other contaminants; assuring the maintenance of the instrument's lifespan.

The cleaning can happen through two kinds of procedures:

I - Manual Cleaning

Manual procedure by means of physical action applied to the instrument's surface. You can use: soft-bristled brush and long cable, wire brush for drills, brush for cleaning lumen, sink with deep tub faucet with steerable jet, detergent and running water.

II - Mechanical Cleaning

Automated procedure by means of water jet washers or low frequency ultrasound, that operates under different conditions of time and temperature

DRYING

The instruments must be opened and dried with compressed air pistols with no oil or humidity, or they can be dried with paper towels and clean lint-free cloth.

VISUAL INSPECTION

This step verifies the efficiency of the cleaning process and the integrity conditions of the article. If necessary, proceed again to cleaning or replace the article. The deteriorated instruments or the ones that show corrosion indications must be separated and sent to re-wash.

STERILIZATION PACKAGE

For autoclave's sterilization, the strictly cleaned and dried material must be packed in packages made with material that allow the passage of steam. The most recommended is the surgical paper. During this step it's important to use chemical indicators to evaluate the presence of critical parameters of the steam sterilization: time, temperature and presence of steam. These tapes react chemically altering its color and should be placed inside each package before sterilization.

STERILIZATION

Sterilization is the process that aims to destroy or eliminate all microbial life forms through physical or chemical procedures. To ensure sterilization, it is essential that the steps already mentioned here are correctly followed. In an autoclave, the maximum temperature is 134-137°C, while in dry heat or hot air devices, the maximum temperature is 180°C.

STORAGE

Dry instruments thoroughly before storing them.



Earth Care Program & Reward

It is important that we pay attention to our environmental concerns and take action. There has never been a more critical time to protect our precious planet, particularly with so many goods being manufactured and processed without being properly recycled around the world. MA Dental is ecstatic to be a part of the Earth-Care project.

MA Dental's Earth Care Program is an environmentally friendly initiative that focuses on the recycling of dental instruments. The Earth Care program facilitates the environmentally friendly disposal of old and used dental instruments, regardless of brand, and provides new MA Dental instruments to dental professionals and businesses.

The Earth-Care program was established in 2018 with the goal of being environmentally conscious and reducing dental waste as much as possible. We carefully select the salvageable instruments sent to us through the Earth care program, recondition them, and distribute them to charities and donations in Europe that we support. Furthermore, if the instruments are worn out and cannot be reconditioned, we send them to our recyclers for proper disposal.

Please visit our website www.madental.dk to learn more about the policy, terms and conditions, and how it works.

MA DENTAL

Best-selling dental instruments in Scandinavia

www.madental.dk | www.instrudents.com
info@madental.dk | +45 7060 5922 | VAT: DK39291533
Produktionsvej 26 | 2600 Glostrup | Denmark
[f](#) madental.dk [in](#) ma-dental

